

Structural Chemistry of Transition-Metal Complexes Containing Arsenic-Arsenic Bonds

ANTHONY-JOSEPH DIMAIO and ARNOLD L. RHEINGOLD*

Department of Chemistry and the Center for Catalytic Science and Technology, University of Delaware, Newark, Delaware 19716

Received May 1, 1989 (Revised Manuscript Received August 7, 1989)

Contents

I. Introduction	169
II. Complexes with Rings of RAs Units	170
III. Complexes Containing Chains of Coordinated RAs Units	172
A. Mononuclear Complexes (Metallacycles)	172
B. Dinuclear Complexes	175
C. Mononuclear Complexes with Tetraorganodiarsine Ligands and Dinuclear Complexes with Tetraorganodiarsine Bridges	176
D. Metal-Substituted Diarsine Complexes	177
IV. Complexes Containing Unsubstituted Arsenic Atoms	179
A. Tetrahedral Structures	179
B. Arsenic-Substituted Tetrahedral Complexes	181
C. Incomplete Tetrahedral Structures	182
D. Dinuclear Complexes with Rings of Arsenic Atoms	183
V. Complexes of Arsenic Rings Containing Chalcogen Heteroatoms	186
VI. Miscellaneous Complexes	187
VII. Concluding Comments	188

I. Introduction

Hybrid transition-metal, main-group clusters, in which both classes of elements define the molecular framework, exist at the interface between metallic clusters, with structures at or near *closo* limits, and nonmetal clusters which are often much more open (electron rich). Because of this, these clusters enjoy an impressive structural diversity. Only in the past two decades in which X-ray crystallography has been available as a routine analytical tool has this field begun to mature. The broader aspects of hybrid clusters have been recently reviewed.^{1,2} The main-group elements appearing in these clusters come almost exclusively from groups 14-16, while the transition elements come from across the periodic table. The structures of clusters containing group 15 elements have been especially diverse due to the broad range of possible coordination geometries and donor capacities for the elements P, As, Sb, and Bi, their incorporation in clusters as either atoms or as RE units (or mixtures of both), and their ability to join to form rings and chains. Several reviews of phosphorus-containing clusters have recently appeared covering clusters containing phosphinidene (RP) units,^{3,4} with naked phosphorus atoms,⁵ and with rings and cages of phosphorus atoms.⁶ Com-



Tony DiMaio was born in Providence, RI, in 1962 and raised in Westerly, RI. After receiving his B.S. degree at the University of Rhode Island in 1984, he entered graduate school at the University of Delaware. Under the direction of Professor Arnold L. Rheingold, he received his Ph.D. in inorganic chemistry in 1989. His dissertation topic involved the formation of transition-metal organometallic clusters from *cyclo*-polyarsine precursors. He is currently a postdoctoral associate with Professor John Ellis at the University of Minnesota.

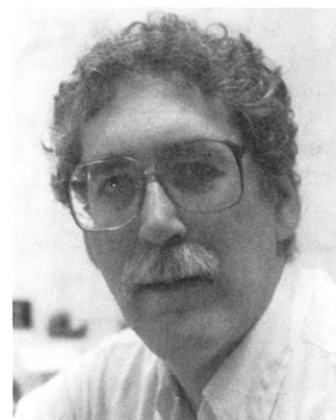

Arnold Rheingold was born in Chicago in 1940 and raised in Rockford, IL. After receiving B.S. and M.S. degrees from Western Reserve University, he was for 2 years a project leader in organometallic chemistry for the Glidden Co. In 1969 he received his Ph.D. from the University of Maryland and spent a postdoctoral year at Virginia Polytechnic Institute with Professor Raymond E. Dessy. He began his academic career in 1970 at SUNY-Plattsburgh, and in 1981 he joined the faculty of the University of Delaware, where he is currently Professor of Chemistry. Between Plattsburgh and Delaware he spent a sabbatical year with Professor Melvyn R. Churchill, SUNY-Buffalo, learning about crystallography.

plexes of group 15 elements containing E-E multiple bonds have also been reviewed.^{7,8}

Complete structural characterization has been of greater importance for the heavier group 15 elements than for phosphorus due to the lack of spin- $1/2$ nuclei

for NMR studies. Our own work in recent years has emphasized the synthesis and structure of clusters containing arsenic, in particular clusters (broadly defined) containing As-As bonds that take advantage of the element's strong tendency to form stable catenates.

One of the main attractions in studying clusters containing arsenic (from among the other group 15 elements) is its position midway in the pnictogen family and the range of bond energies conferred by this position. A compromise is obtained between the significantly higher bond energies for bonds to phosphorus, which often create energy barriers to thermal conversions that prevent isolation of intermediates, and the much lower bond energies associated with antimony and bismuth, which almost always ensure that only thermodynamically favored products will be isolated. In several instances it has been possible to isolate sequences of products by successively increasing reaction temperatures, each step of the conversion sequence beginning with its isolated precursor. Although we have been tempted to call these sequences "mechanisms", the relatively low barriers to reaction generally encountered ensure that conversions occur along a multitude of simultaneous, essentially isoenergetic pathways involving complex, interrelated equilibria of various oligomeric forms of the arsenic synthon.⁹

Arsenic's mid-family position combines properties of both the nonmetallic and metallic members of group 15. Therefore, the structural chemistry of metal-coordinated arsenic is the most diverse of the pnictogens, perhaps of any element in groups 14-16. Elements in group 14 seldom exhibit significant donor capability, and group 16 elements lack the range of substitutional possibilities of a pnictogen element.

In the 12 years since this field was last reviewed,¹⁰ the number of examples of complexes containing As-As bonds has increased tenfold; there are now well over 100 such complexes known of which over half have been crystallographically characterized. This review will focus on structural aspects of all known^{11a} crystallographically studied transition-metal compounds containing As-As bonds and at least one metal-As bond. Many of the compounds included in this review have appeared only in preliminary communications with very brief structural commentary or in full-length reports in which structures appear with minimal commentary. Some only give tables of bond parameters and an ORTEP drawing. Therefore, it is essential to bring together for comparison and analysis the broad array of structures covered in this review.

The organization will be based on both the type of As concatenation and the structure of the cluster formed, and not primarily on synthesis methods or reagents. Due to the frequency with which structural conjectures in this field have been proved incorrect by subsequent crystallography, this review will consider in detail only those compounds for which unambiguous structural proof exists. Fortunately, at least one member of each class of structure has been crystallographically determined. In cases where authors and journals have provided atomic coordinates, we have verified the reported bond metrics.^{11b} A few additional compounds are discussed where structural assignments appear reasonably certain either from spectroscopic data alone or from direct similarities to structurally characterized complexes.

For the purpose of this review, the polyarsine-transition-metal coordination compounds included are classified first with respect to whether or not they possess an organic substituent directly bound to the arsenic. For those that contain RAs units, further classification is based upon the number of transition-metal atoms in the cluster, as well as the number of organic substituents bound to arsenic (R_2As vs RAs). For those complexes that contain unsubstituted arsenic atoms, the structural type and geometric arrangement of the heavy atoms in the compound are used to define categories. Finally, recognition is given to a number of complexes that contain chalcogens within the heavy-atom structure, and some interesting structures that defy categorization are given in section VI as "miscellaneous compounds".

II. Complexes with Rings of RAs Units

cyclo-Polyarsines (CPA's), *cyclo*-(RAs)_n (R = organic group, $n = 3-6$), are versatile reagents for the preparation of transition-metal complexes.^{9a} Many different types of products are obtained from CPA precursors.

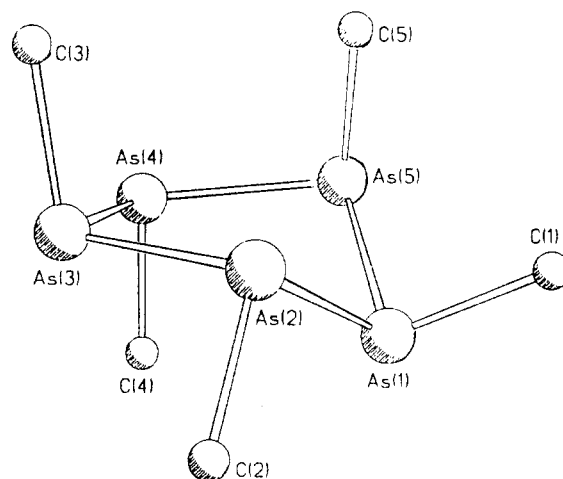

1

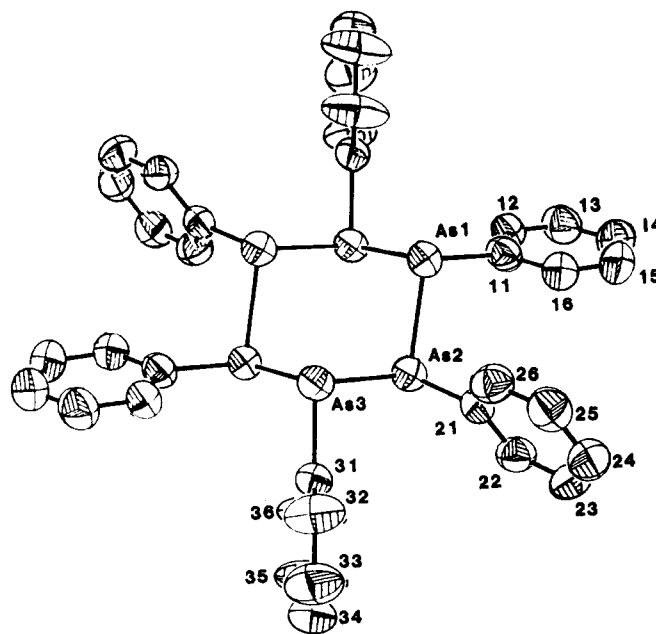

2

Some retain the intact ring structure, others involve ring expansion (never contraction), and open chains of RAs units may be formed with retention, expansion, or contraction of chain lengths. In addition to ring and chain modification, CPA's may also lose organic substituents under mild conditions to form naked arsenic atom species. Additionally, combinations of these outcomes may occur in the same reaction and even in the same product. When in a highly purified state, CPA's are generally thermally very stable; both *cyclo*-(MeAs)₅ (1) and *cyclo*-(PhAs)₆ (2) are unchanged at 200 °C.^{9,12} However, trace amounts of some nucleophiles (e.g., I⁻) cause rapid ring-opening reactions; NMR spectra of such systems reveal a complex array of oligomeric forms.¹³⁻¹⁶ CPA's are among the most versatile and accommodating synthons known. Whatever form best satisfies the steric and electronic requirements of the metallic moiety is available from the multitude of interrelated equilibria.

Metal carbonyls from groups 6 and 7 under mild reaction conditions (80-100 °C, aromatic solvents in sealed tubes) readily undergo carbonyl substitution reactions when treated with CPA's. From among other products formed (discussed below), dinuclear complexes containing expanded ring sizes are often obtained. For instance, arsenomethane, the common name for 1, on combination with group 6 hexacarbonyls forms products containing expanded rings of RAs units such as [*cyclo*-(MeAs)₉Cr₂(CO)₆] (3)¹⁷ and [*cyclo*-(MeAs)₁₀Mo₂(CO)₆] (4).¹⁸ The heavy-atom frameworks for 3 and 4 are derived from cubane; 3 has the structure of tris-

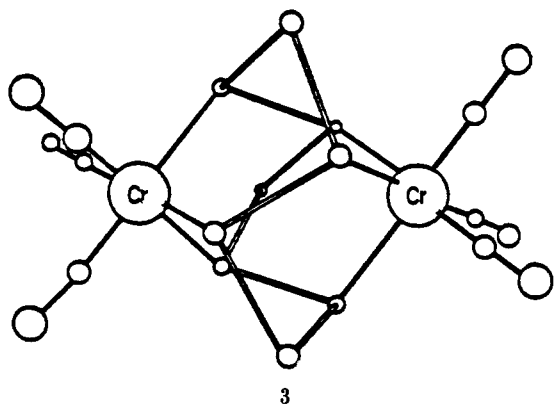

3

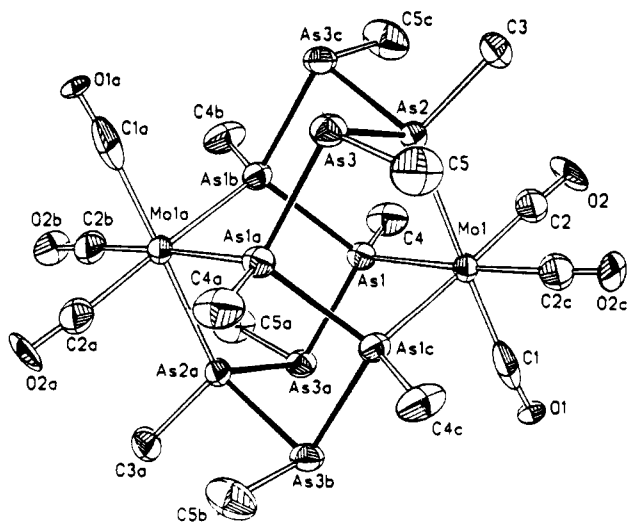

4

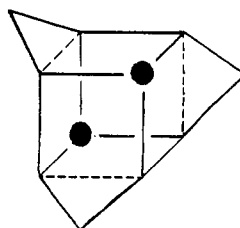

5

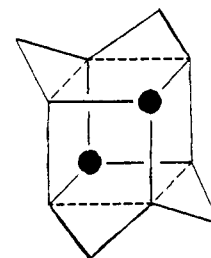

6

homocubane (5),¹⁹ and 4 has the structure of tetrakis-homocubane (6). The ten-membered RAs ring in 4 has the boat-chair-boat conformation of cyclodecane. The trishomocubane structure for 3 has a direct isolobal relationship to its organic analogue¹⁹ and to P₁₁³⁻, As₁₁³⁻, and As₂₂⁴⁻, which also possess the trishomocubane structure.²⁰⁻²³ No purely main-group analogues to the structure of 4 are known. The As-As and metal-As distances in 3 and 4 are typical.

When Mn₂(CO)₁₀ or Re₂(CO)₁₀ replaces the group 6 metal hexacarbonyl in reactions with 1, the products would be expected to be different, if each metal center maintains an 18-electron configuration. However, if the ubiquitous nature of the trishomocubane structure prevails, structural and electronic adjustments must be made to compensate for rhenium's additional electron. The main product of the reaction of Re₂CO₁₀ 1 is {[*cyclo*-(MeAs)₇(As)Re(CO)₄]Re₂(CO)₆} (7),²⁴ containing a

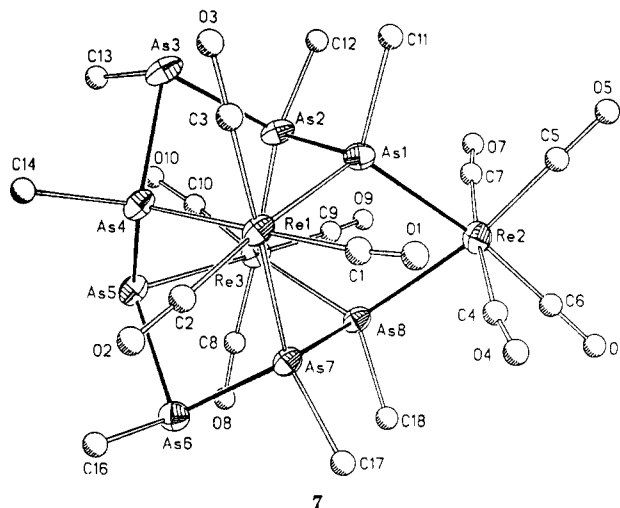

7

nine-membered As₈Re ring coordinated to two Re(CO)₃ groups possessing an overall heavy-atom, trishomocubane structure. Close inspection of the figure for 7 shows that one of the As atoms in the ring, As(5), has lost its methyl group. As a member of a chain, an RAs unit is normally a two-electron donor, the same as a tertiary arsine. However, when the methyl group is lost, the As atom becomes a one-electron donor (the non-bonding pair is not used in bonding to Re) as shown in Figure 1. This modification in donor capacity thus maintains an outward directed pair of electrons consistent with standard cluster element descriptions.

In support of the reduced donor capacity for As(5) is the Re(3)-As(5) bond distance, 2.646 (3) Å, which is significantly longer than the other two Re(3)-As distances, 2.553 (4) and 2.612 (4) Å. In this way, the electron count at Re(3) is reduced by one, reestablishing the isolobal analogy to trishomocubane. The electron

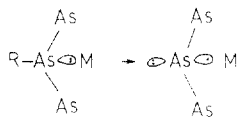
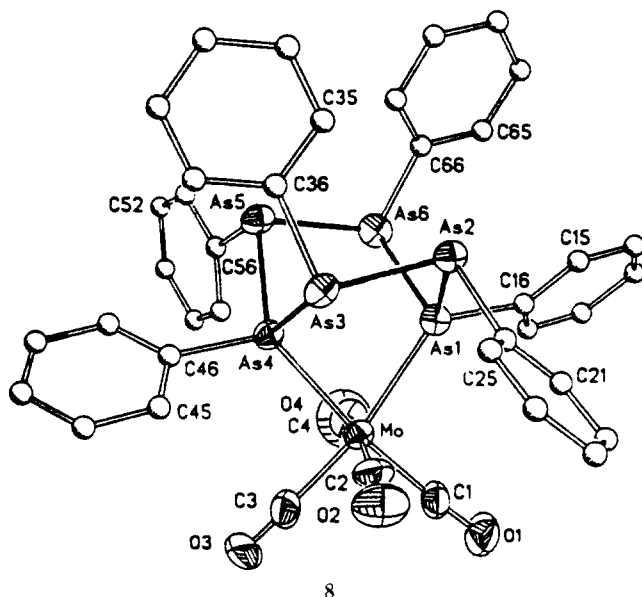

Figure 1.

count at Re(1) is reduced by a different process; instead of an As atom losing substitution, a naked As atom is "synthesized" in the form of an $\text{Re}(\text{CO})_4$ group (at Re(2)). Since $\text{Re}(\text{CO})_4$ is a 15-electron group, it is the electronic equivalent of a 5-electron As atom. In the two $\text{Re}(2)\text{-As}$ bonds, a total of three electrons are accepted to complete an 18-electron octahedral configuration. If As(8) donates one electron and As(1) donates two electrons to Re(2), then As(1) donates only one electron to Re(1), completing its octadecet. Affirmation is found in the $\text{Re}(1)\text{-As}(1)$ distance (2.605 (3) Å), which is longer than the other $\text{Re}(1)\text{-As}$ bonds, 2.543 (4) and 2.567 (4) Å.

The formation of a trishomocubane analogue is important in that the change from Mo to Re did not result in a change in the gross structure of the cluster. Rather, both the main-group and transition-metal components of the cluster adapted to fit a stable conformation based on a characteristic main-group structure, not a traditional transition-metal structure.

In reactions related to the formation of 4, in which 2 replaces 1, it has been possible to isolate structures containing an intact cyclohexamer ring. Hexaphenylcyclohexaarsine crystallizes in the expected "chair" conformation²⁵ but coordinates to a $\text{Mo}(\text{CO})_4$ group (from $\text{Mo}(\text{CO})_6$) in a twist-boat form using the 1 and 4 (bow and stern) ring positions in forming [*cyclo*-(PhAs)₆Mo(CO)₄] (8).²⁶ The average As-As distance



in 2 is 2.459 Å and changes very little (2.454 Å) on forming 8.^{26a} However, the As-As-As angles in 8 (av 98.6°) are considerably larger than in 2 (av 91.1°), which also contains two slightly acute As-As-As angles. The shortest transannular As...As distance in 8 (3.196 (1) Å) is considerably shorter than any found in 2 and demonstrates why the twist-boat conformation is preferred for ligation purposes. While it is attractive in its simplicity to propose that 8 forms by a direct dicarbonyl substitution involving only a ring conformation change

in 2, the probable course of events is likely more complex. Compound 8 is very similar in structure to [*cyclo*-(MeP)₆W(CO)₄],²⁷ which is formed from *cyclo*-(MeP)₅ under conditions identical with those of 8, yet formation of the P complex must involve ring expansion. The presence of six-membered rings in both 2 and 8 is likely more coincidental than mechanistically informative. Under somewhat more vigorous conditions, 2 reacts with either $\text{Mo}(\text{CO})_6$ or (mesitylene)Mo(CO)₃ to form $\text{Mo}_2(\text{CO})_6[\text{i cyclo}-(\text{PhAs})_9]$ (9), which is structurally analogous to 3.¹⁸

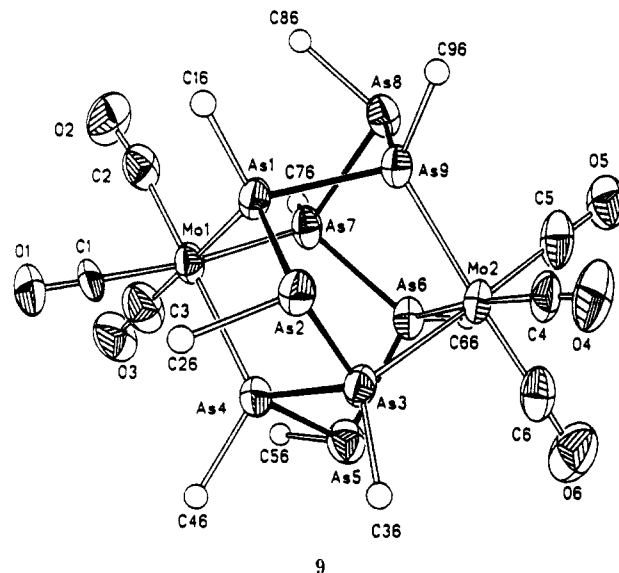

Formation of dinuclear structures containing nine- or ten-membered rings of RAs units is a common outcome of reactions of metal carbonyls under nonforcing conditions (generally temperatures under 150 °C). That these reactions, and many subsequently described reactions, occur in sealed tubes, but have consistently failed to give the same products in open systems, demonstrates the importance of CO containment in determining the products formed. Pressures of 30–50 atm may be autogenerated. The ultimate size of the ring expansion in these dinuclear complexes appears to be the result of two factors: (1) six of the ring RAs units must coordinate, and uncoordinated "spacers" are needed to accommodate the nearly regular octahedral metal-atom environments (Cr is better fitted by a nine-membered ring, Mo by a ten-membered ring), and (2) steric factors determined by the R group are also important (larger phenyl rings form smaller cyclohexamer complexes). No expanded-ring complexes are known for Cp-substituted metal carbonyls. (Cp = $\eta^5\text{-C}_5\text{H}_5$, Cp' = $\eta^5\text{-C}_5\text{H}_4(\text{CH}_3)$, and Cp* = $\text{C}_5(\text{CH}_3)_5$.)

III. Complexes Containing Chains of Coordinated RAs Units

A. Mononuclear Complexes (Metallacycles)

Cp_2TiCl_2 combines directly with "arsenoethane", *cyclo*-(EtAs)₅, in refluxing THF to form $\text{Cp}_2\text{Ti}(\text{EtAs})_3$ in 52% yield. The product was characterized by mass spectrometry and IR spectroscopy.²⁸ Nearly quantitative yields of the related products $\text{Cp}_2\text{Ti}(\text{RAS})_3$ (R = Ph (10)²⁹ and Me (11)³⁰) have been obtained by first re-

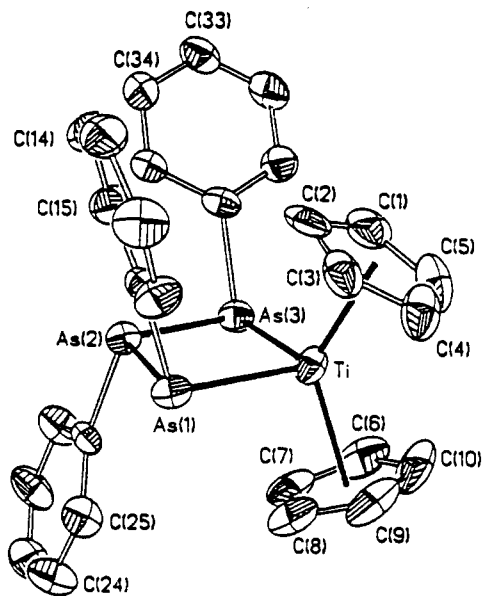

10

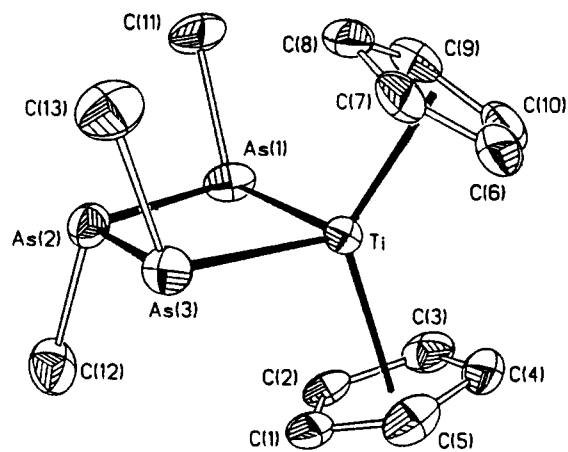

11

ducing Cp_2TiCl_2 with Mg followed by treatment with either 1 or 2. Crystallographic characterization of both the Me and Ph derivatives reveals essentially identical structures: a nearly planar TiAs_3 ring bisects the Cp-(centroid)-Ti-Cp(centroid) angle with the R group at the central As atom positioned oppositely to those adjacent to Ti. The As-As bond distances are very similar to those of the parent *cyclo*-polyarsines, but the As-As-As angle in 10, $109.51(6)^\circ$, is the largest known, and the As-Ti-As angle, $96.8(1)^\circ$, is also obtuse. The effect is to create a short $\text{Ti}\cdots\text{As}(2)$ distance ($3.173(1) \text{ \AA}$), which may be stabilizing.

Curiously, in the isolobal complex Cp^*TiS_3 the TiS_3 ring is highly puckered; the dihedral angle between the S-Ti-S plane and the S_3 plane is 49° .³¹ Although the size of the Ti-S ring system appears determined by the presence of the Cp* groups (the trisulfido Cp analogue is not known; Cp_2TiS_5 is obtained instead³²), the puckering is not; a planar ring would be less sterically demanding than a puckered one. Also arguing against a steric explanation of the puckering seen in the sulfur complex and its absence in the RAs complexes is the nearly identical framework and substituent arrangement for 10 and 11. In titanacyclobutanes, the TiC_3 ring is nearly flat.³³

Werner and co-workers report that the thermolysis of $\text{Cp}^*\text{Rh}(\text{CO})(\eta^2\text{-CH}_2\text{AsPh})$ (itself formed from

$\text{Cp}^*\text{Rh}(\text{CO})(\text{CH}_2\text{I})(\text{I})$ and LiAsHPh) forms $\text{Cp}^*\text{Rh}(\text{CO})(\text{PhAs})_3$ (12), which contains the same *cyclo*-

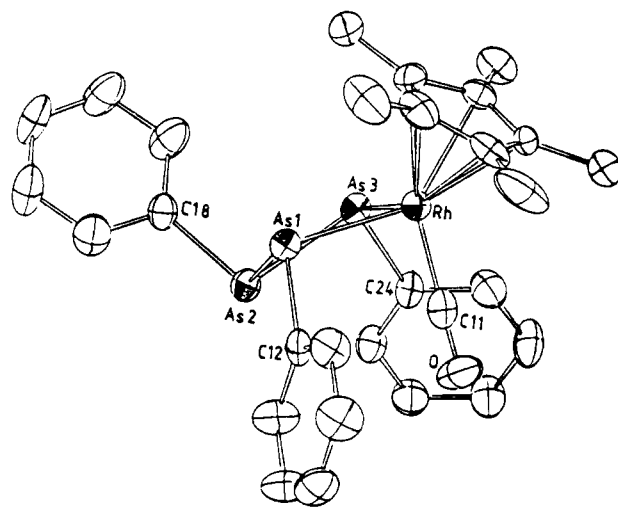

12

metallatetraarsine ring found in 10.³⁴ However, in 12 the ring is puckered with a 23.1° dihedral angle between the RhAs_2 and As_3 planes. The As-As distances are similar to those of 10, which are typical of uncoordinated *cyclo*-polyarsines. The As-As-As angle in 12 is very acute, $82.97(5)^\circ$, whereas an unusually obtuse angle was found in 10. The structural differences between 10 and 12 increase the credibility of the presence of a weakly attractive interaction between Ti and As(2) in 10, accounted for by the deficient 16-electron count at Ti compared to the 18-electron count at Rh in 12.

One of the products obtained by Jones and Whittlesey from the combination of $\text{Na}_2\text{Cr}_2(\text{CO})_{10}$ with *t*- Bu_2AsCl in THF at room temperature, after treatment with PPN^+Cl^- , is $\text{Cr}(\text{CO})_4[\text{ClAs}(t\text{-Bu})\text{As}(t\text{-Bu})_2]$ (13),³⁵

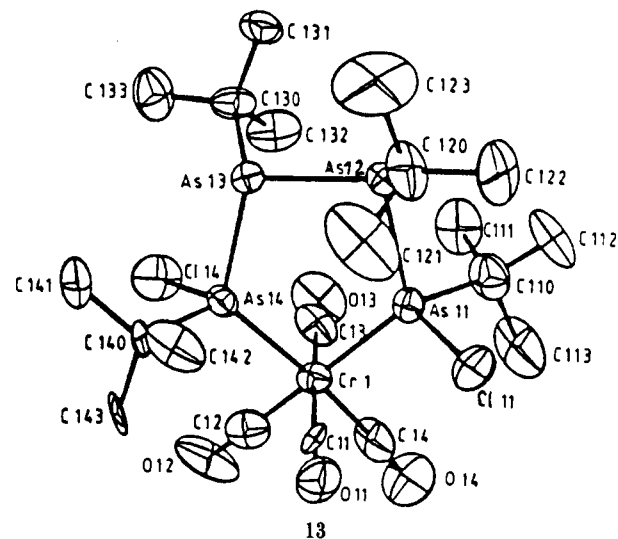

13

which differs from compounds 10-12 by the presence of disubstituted (*t*-Bu and Cl) terminal As atoms. Thus, each disubstituted terminus functions as a two-electron donor, compared to the apparent one-electron donation from the termini of compounds 10-12. This effect was illustrated above in the discussion of 7 (see Figure 1). The CrAs_4 ring is nearly planar with the *t*-Bu groups alternating above and below the plane around the ring. The As-As distances alternate in a long-short-long

pattern; the two As-As bonds adjacent to Cr are 2.478 (1) and 2.479 (1) Å, while the unique As-As distance is 2.427 (1) Å, compared to a normal single-bond distance of about 2.45 Å.

Mononuclear complexes containing the η^2 -RAs-AsR ligand may be regarded, by isolobal logic, as analogues of η^2 -olefin complexes. The most direct example of this is $(\text{CO})_4\text{Fe}(\eta^2\text{-PhAsAsPh})$ (14) formed from $\text{Na}_2\text{Fe-}$

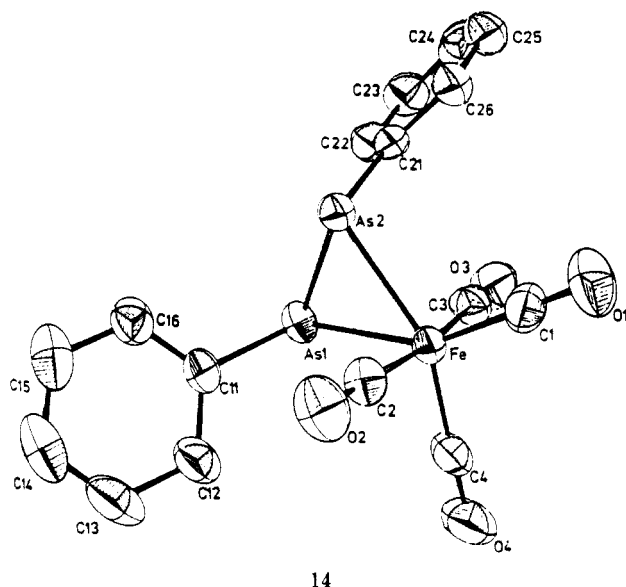

14

$(\text{CO})_4 \cdot 1.5\text{dioxane}$ and PhAsCl_2 .³⁶ One of the interesting features of this synthesis is the formation of an As=As bond as part of the condensation process. In 14, the diarsenic group occupies an equatorial position with the FeAs_2 plane in the equatorial plane; the phenyl rings are trans. The As-As distance, 2.365 (2) Å, is about 0.1 Å shorter than a normal As-As single bond and is in a range appropriate for a complexed double bond. An essentially similar structure has been found for $[\text{Fe}(\text{C}-\text{O})_4(\text{AsC}_6\text{F}_5)_2]$ (15) in which pentafluorophenyl groups replace the phenyl groups in 14; 15 was obtained by the reaction of $\text{Fe}(\text{CO})_5$ with *cyclo*-($\text{C}_6\text{F}_5\text{As}$)₄.³⁷

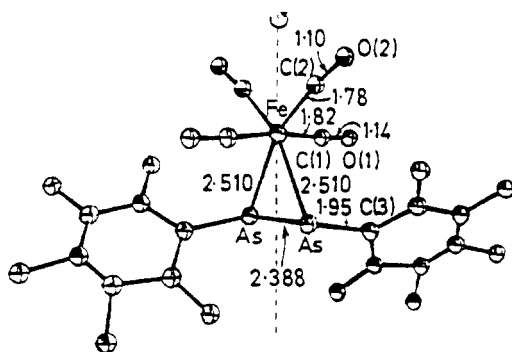

15

An NiCl_2 complex of 2,3-bis(diphenylphosphino)-*N*-methylmaleimide reacts with $\text{PhAs}(\text{SiMe}_3)_2$ to form 16, which contains an η^2 -PhAsAsPh group and a square-planar Ni environment. The As-As distance, 2.372 (3) Å, is very similar to that found in 14.³⁸

Although isolobal relationships are powerful tools in the analysis of structures (as demonstrated frequently throughout this review), significant differences may exist in the details of the metal-ligand bonding schemes. In the present context, the structures of metal complexes of ethylene and the diarsinidene group,

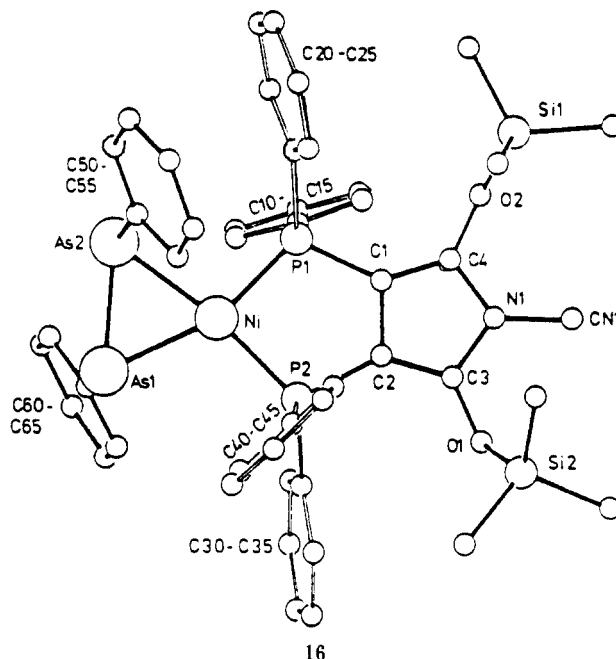

16

RAsAsR, may differ significantly due to the different bonding modes available to each. While the traditional Dewar-Chart-Duncanson model serves well for most metal-olefin complexes, a very different set of orbitals are available to the diarsinidene group, which may form two single metal-As bonds or involve the lone pairs in metal-ligand bonding.

An example is found in the comparison of the structures of $\text{Cp}_2\text{Nb}(\text{R})(\text{olefin})$ ³⁹ and $\text{Cp}_2\text{Nb}(\text{H})(\eta^2\text{-RAs-AsR})$,^{40,41} the diarsinidene complex has recently been

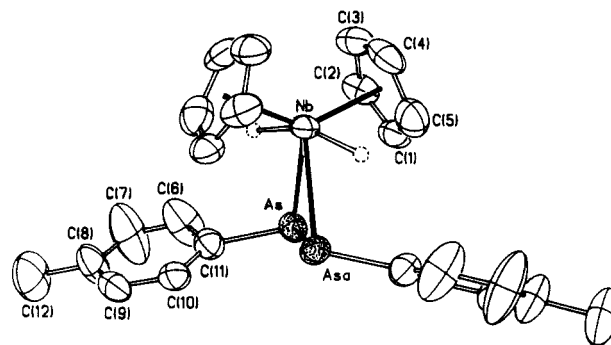

17-1

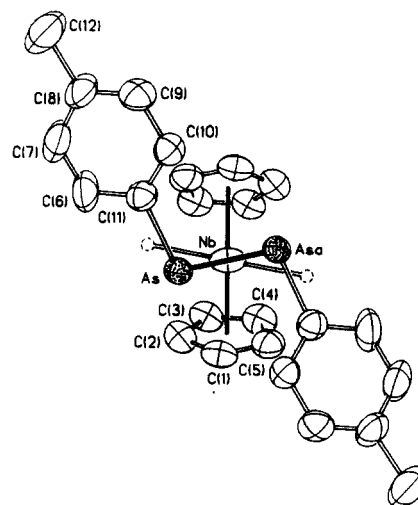

17-2

prepared by the reaction of a *cyclo*-polyarsine with Cp_2NbH_3 in refluxing benzene for R = methyl, phenyl, and tolyl (17). (In the figure for 17, the found hydride atom is shown in two disordered, half-occupancy sites by the broken circles.) The hydride ligand appears at $\delta = -2.67$ in the ^1H NMR spectrum of 17 (R = Ph), a value very similar to the chemical shift found in $\text{Cp}_2\text{Nb}(\text{H})(\text{C}_2\text{H}_4)$ ($\delta = -2.95$).³⁹

Unfortunately, this most direct analogue of 17 has never been structurally characterized, but that of $\text{Cp}_2\text{Nb}(\text{Et})(\text{C}_2\text{H}_4)$ is known:⁴² as expected from the theoretical description⁴³ of the bonding in Cp_2Nb complexes, the ethyl group and olefin occupy a plane perpendicular to the centroid-Nb-centroid plane (sometimes referred to as the "wedge" plane) with the olefin to one side of the Cp-Nb-Cp plane. However, in 17, the RAs-AsR group is bisected by the Cp-Nb-Cp plane and is conspicuously twisted out of the wedge plane by $12.8(2)^\circ$; the hydride plane is similarly twisted. The Cp-Nb-Cp angle ($136.4(1)^\circ$) is similar to that of other Cp_2Nb structures; in $\text{Cp}_2\text{Nb}(\text{Et})(\text{C}_2\text{H}_4)$ the same angle is 132.4° .⁴²

To form an 18-electron complex, the RAsAsR group donates two electrons and forms single Nb-As bonds, in keeping with the long Nb-As distance (2.754 (1) Å) found; the As lone pairs are not involved in bonding to Nb. The As-As distance (2.369 (1) Å) is similar to that found in compounds 14-16. The twisting of the diarsinidene ligand out of the wedge plane may be seen as an accommodation of the pyramidal geometry at As to facilitate overlap with the b_2 orbital (largely Nb d_{yz}) in the wedge plane.

B. Dinuclear Complexes

In contrast to the reactions of 2 and its tetrameric pentafluorophenyl analogue with $\text{Fe}(\text{CO})_5$, 1 forms complexes containing non-olefinic chains of RAs units. In the olefinic complexes (see section III.A), only aromatic substitution is seen; in these cases each As atom functions as a one-electron donor. With methyl substitution, the RAs group more often serves as a three-electron donor, in keeping with the greater σ -basicity of methyl-substituted compared to phenyl-substituted phosphines and arsines. In the reaction of 1 with $\text{Fe}(\text{CO})_5$, a major product is $[\text{Fe}_2(\text{CO})_6][\mu, \eta^2\text{-catena}(\text{CH}_3\text{As})_4]$ (18), which contains a four-membered chain

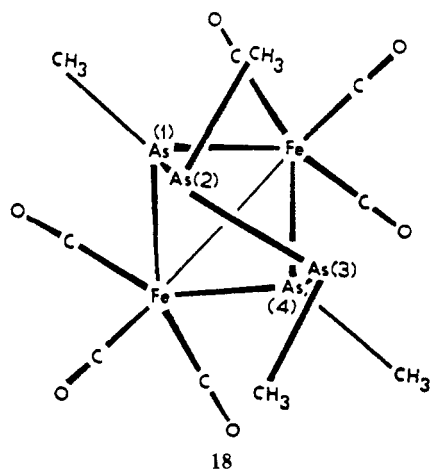

of MeAs units bridging both Fe atoms and a metal-metal bond.⁴⁴⁻⁴⁶ The unique As-As bond is short, 2.391 Å, while the other two are normal. The "nonbonded" As(1)⋯As(4) distance is notably short, 2.888 Å, and may signify substantial bonding character in the interaction. Since the precursor 1 is a five-membered ring, loss of a MeAs group accompanies this ring-opening reaction.

In a very similar reaction with 1, in which $[\text{Cp}_2\text{Mo}(\text{CO})_3]_2$ replaces $\text{Fe}(\text{CO})_5$, a five-membered chain is formed in $[\text{Cp}_2\text{Mo}_2(\text{CO})_4][\mu, \eta^2\text{-catena}(\text{CH}_3\text{As})_5]$ (19).^{47a}

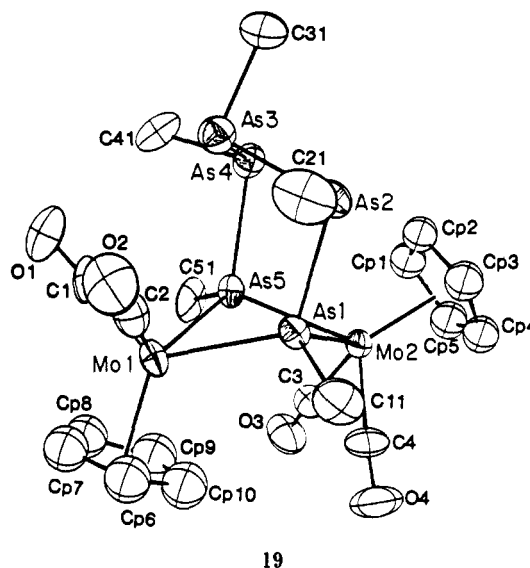

Since $\text{CpMo}(\text{CO})_2$ is a 15-electron fragment, no metal-metal bond is required to complete the Mo environment (the Mo⋯Mo distance is 4.169 (1) Å). The As⋯As distance (2.835 (2) Å) is even shorter than in 18. The additional RAs unit in 19 (compared to 18) may be required to span the greater distance created by the absence of an Mo-Mo bond; conversely, the Fe-Fe bond in 18 may force a contraction in chain length. The As-As bond distances and the As-As-As angles are unexceptional. When 19 is heated rapidly to 190°C in toluene in a sealed tube, both complete demethylation and decarbonylation occur to form $(\text{CpMo})_4(\mu_3\text{-As})_4$ containing an Mo_4 tetrahedron and a μ_3 -As atom in each face. Completion of the crystallographic characterization was not possible; crystallographically imposed threefold axes in cubic symmetry created fully disordered Cp rings.^{47a} Although not structurally characterized, $[\text{Mn}_2(\text{CO})_8(\text{CH}_3\text{As})_5]$ is isoelectronic with 19 and presumed to have the analogous structure.⁴⁴

When 10 is isolated, purified, and then thermolyzed at 160°C , the cyclononamer structure cleanly transforms to $[\text{Mo}_2(\text{CO})_6][\mu, \eta^4\text{-catena}(\text{CH}_3\text{As})_8]$ (20), which contains an eight-membered chain coordinated at the 1, 4, 5, and 8 positions bridging both Mo atoms which are bonded (Mo-Mo = 3.094 (2) Å).¹⁸ The structure is very similar to that found for the propyl analogue.¹⁷ The As atoms in 20 are grouped into two As_4 planar arrangements: As atoms 1-4 and 5-8 form the two groups. These planes are nearly perpendicular to the Mo_2As_2 basal plane. The As-As distances occur in a narrow range, 2.45-2.47 Å. The driving force in the conversion of 10 to 20 may be the increased donor capacity of a chain-terminus As atom (three electrons) compared to that of a ring member (two electrons). Thus, ring opening may be viewed as a stabilizing effect.

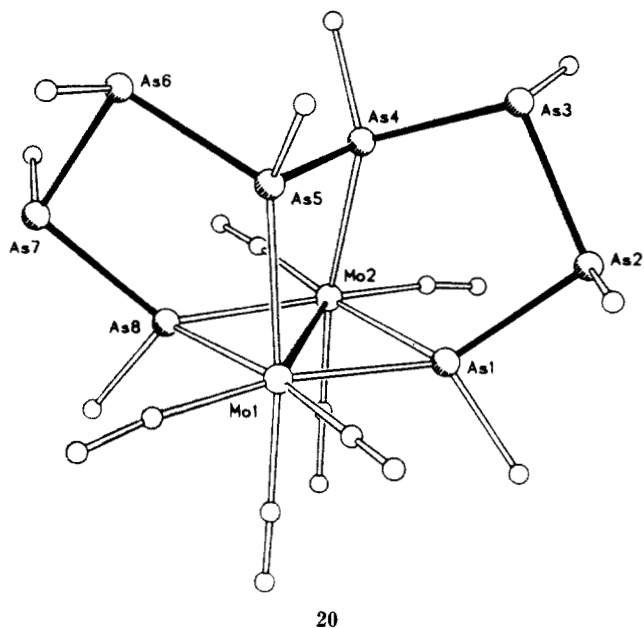

Compound **20** readily inserts 1 mol of dimethyl acetylenedicarboxylate (DMAD) but resists addition of 2 mol, despite use of 20-fold excesses.⁴⁸ The insertion occurs between two uncoordinated As atoms to form **21**,

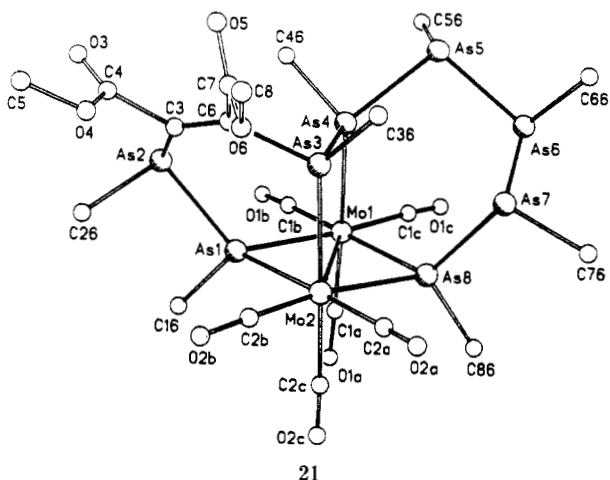

which retains the basic structure of **20**, but in **21** each of the two planes perpendicular to the base contains five atoms, one group of five As atoms, the other, three As and two C atoms. The central As-As bond, As(3)-As(4), is somewhat elongated (2.490 (7) Å), compared to the As-As bond in **20**, and the As-As-As angles are enlarged from their normal values (e.g., As(3)-As(4)-As(5) is 105.9 (2)°) to accommodate acetylene insertion. The Mo-Mo bond is unaffected by DMAD insertion.

C. Mononuclear Complexes with Tetraorganodiar sine Ligands and Dinuclear Complexes with Tetraorganodiar sine Bridges

Rehder has found that CpV(CO)₄ combines directly with tetraphenyldiar sine in a photochemical CO substitution reaction to form CpV(CO)₃As₂Ph₄ (**22**) in which the diarsine serves as a monodentate ligand.⁴⁹ The As-As distance is little changed from that of the parent diarsine.⁵⁰ A tetrasubstituted diarsine may also act as a bidentate ligand if sterically possible; PhAsH₂

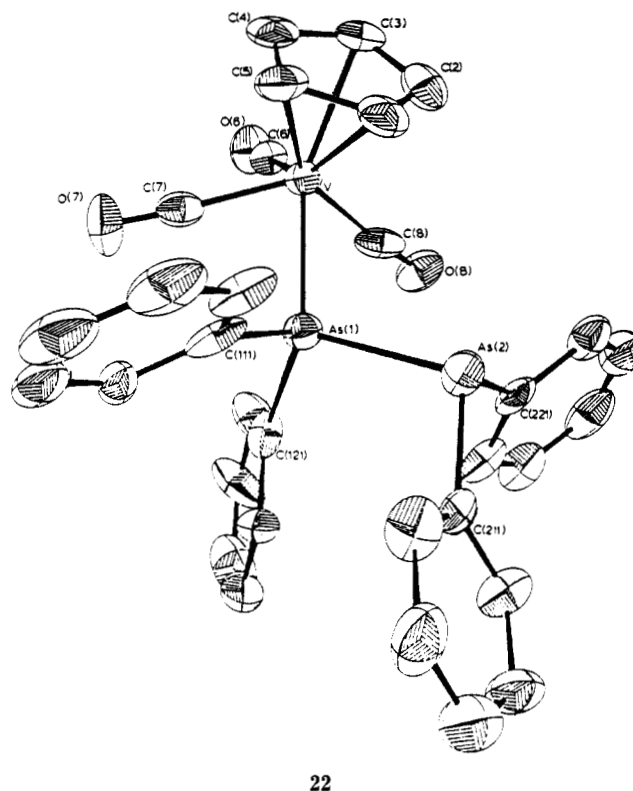

displaces THF from CpMn(CO)₂(THF) and condenses to form [CpMn(CO)₂][μ-Ph(H)AsAs(H)Ph] (**23**), which, by virtue of the small hydride groups, accommodates two CpMn(CO)₂ groups.⁵¹ The As-As distance is 2.460 (1) Å.

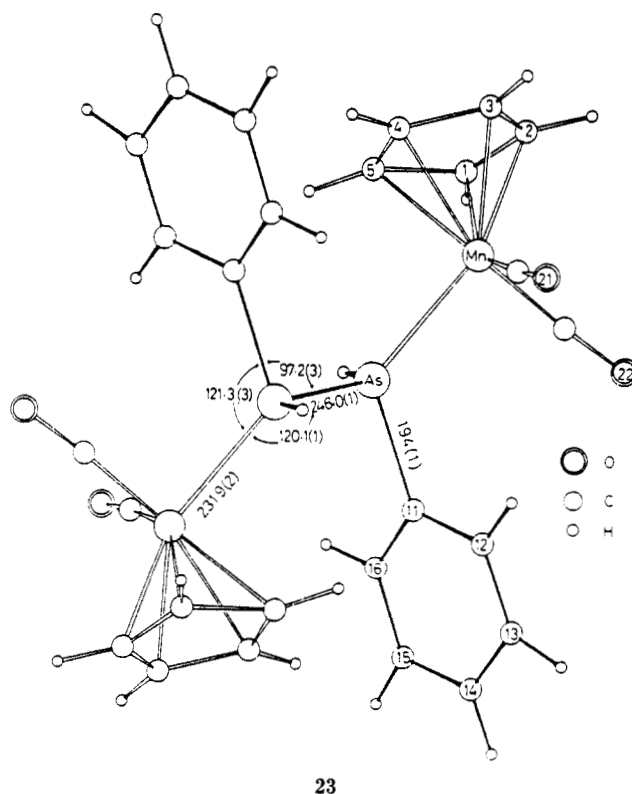

When chains are terminated by R₂As units (instead of RAs units), a single chain terminus cannot simultaneously bridge two metal atoms. The result is the

formation of two-membered $R_2As-AsR_2$ linkages that may span two metals; a more direct description of such complexes is to view them as complexes of tetrasubstituted bidentate diarsines, although the synthesis procedures rarely begin with preformed diarsines. For instance, Cotton and co-workers⁵² found that dimethylarsinic (cacodylic) acid, $(CH_3)_2AsO(OH)$, may be reduced by $Cr(CO)_6$ in diglyme at 130 °C to produce a complex containing two molecules of tetramethyldiarsine bridging two $Cr(CO)_4$ units, $(CO)_4Cr(\mu-Me_4As_2)Cr(CO)_4$ (**24**).⁵² The central Cr_2As_4 six-membered ring is in a chair conformation with a 42° fold angle. The As-As distance (2.442 (1) Å) is normal.

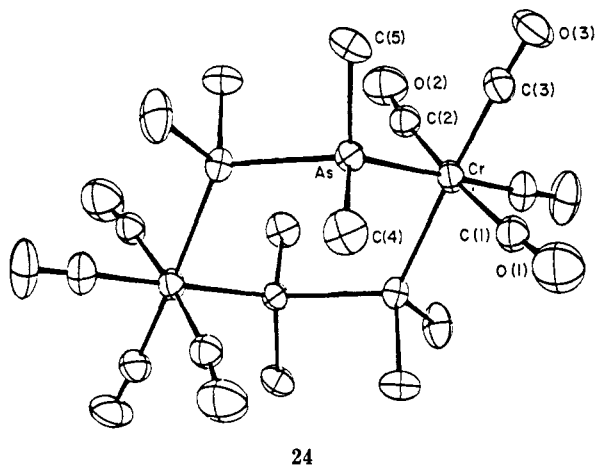

The condensation reaction of Me_2AsCl and $KMn(CO)_5$, studied by Vahrenkamp and co-workers, leads to the formation of $(CO)_4Mn(\mu-Me_2As)(\mu-Me_4As_2)Mn(CO)_3Cl$ (**25**), in which the single Me_2As unit functions

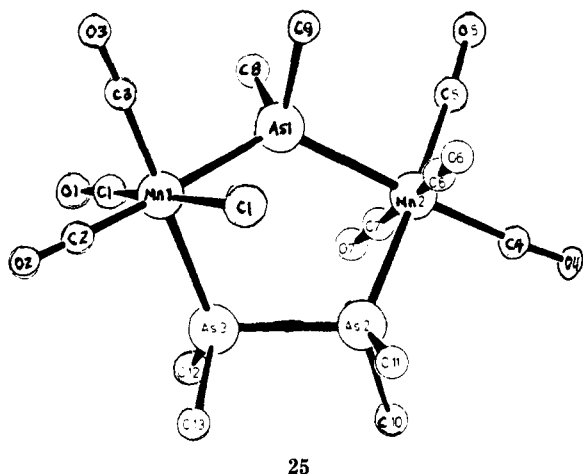

as an asymmetric three-electron donor (donating two electrons to Mn(1) and one to Mn(2)), while the tetramethyldiarsine molecule is a bidentate four-electron donor.⁵³ The As-As distance is somewhat short (2.422 (3) Å), likely the result of bond compression in the formation of the Mn_2As_3 five-membered ring. The direct reaction of $(CO)_5MnBr$ with Ph_4As_2 in refluxing benzene produces $(CO)_3Mn(\mu-Br)_2(\mu-Ph_4As_2)Mn(CO)_3$ (**26**); the As-As distance in this case is somewhat elongated (2.489 (5) Å) to accommodate the two bridging bromine atoms.

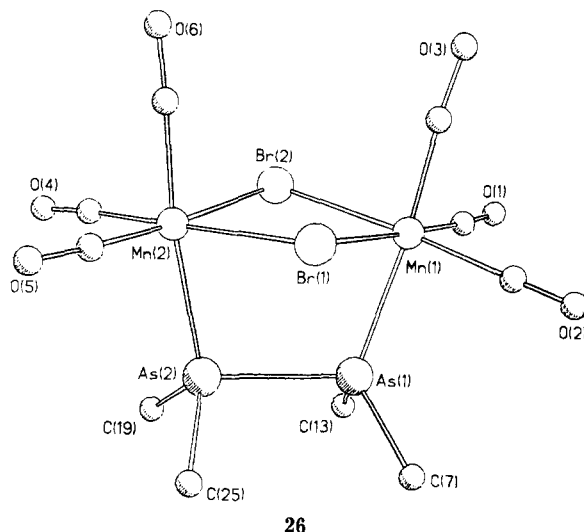

D. Metal-Substituted Diarsine Complexes

One or more of the organic substituents of a tetraorganodiarsine may be substituted by a metallic group to form a metal-substituted diarsine complex. For instance, the reaction of **2** with $[CpFe(CO)_2]_2$ under mild conditions (sealed tube, 90 °C) produces $[CpFe(CO)_2]_2(\mu-Ph_2As_2)$ (**27**), which is most easily described

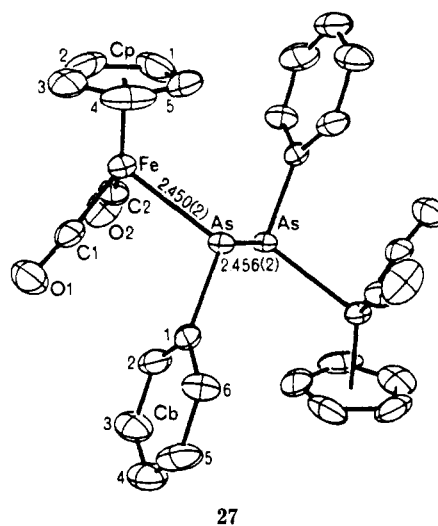

as a *trans*-dimetalladiphenyldiarsine; the rotameric conformation is also *trans*. The As-As distance (2.456 (2) Å) is normal for a single bond.⁵⁵ The Fe-As distance (2.450 (2) Å) is considerably longer than in complexes in which Fe is coordinated to a two-electron-donating As atom, where distances of 2.30–2.35 Å are found. Since the 17-electron $CpFe(CO)_2$ group can accept only a single electron from As, it may be concluded that arsenic retains a nonbonding electron pair capable of further coordination; however, attempts to add 16-electron groups to **27** have all failed, likely for steric reasons.⁵⁰

Huttner⁵⁶ and Herrmann⁵⁷ independently discovered that a diarsenic unit may also be tetrametal substituted, but in the case of $[CpMn(CO)_2]_4As_2$ (**28**) the structure is not a diarsine analogue. Each As atom uses all of its valence electrons in bond formation, leading to planar As atom environments. The two Mn_2As units are joined by a normal As-As single bond (2.445 (4) Å), indicating

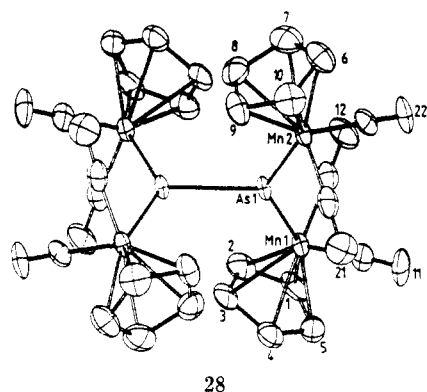

a lack of conjugation between the two three-center 4π -Mn-As-Mn systems of the complex. The diarsenic ligand in **28** may be thought of as an example of a coordinated diarsinidene, $\underline{\text{As}} - \underline{\text{As}}$.

One of the more interesting recent discoveries in main-group chemistry is that the presence of sterically demanding R groups has allowed the isolation of doubly bonded E=E structures from the heavier members of groups 14 and 15, including diarsenes (RAs=AsR). Since double-bond formation does not involve the nonbonding electron pair on As, further coordination is possible. Cowley and co-workers have used $(\text{CO})_5\text{-Cr}(\text{THF})$ to form a monosubstituted diarsene complex $[2,4,6\text{-}t\text{-Bu}_3\text{C}_6\text{H}_2\text{As}=\text{AsCH}(\text{SiMe}_3)_2][\text{Cr}(\text{CO})_5]$ (**29**) in

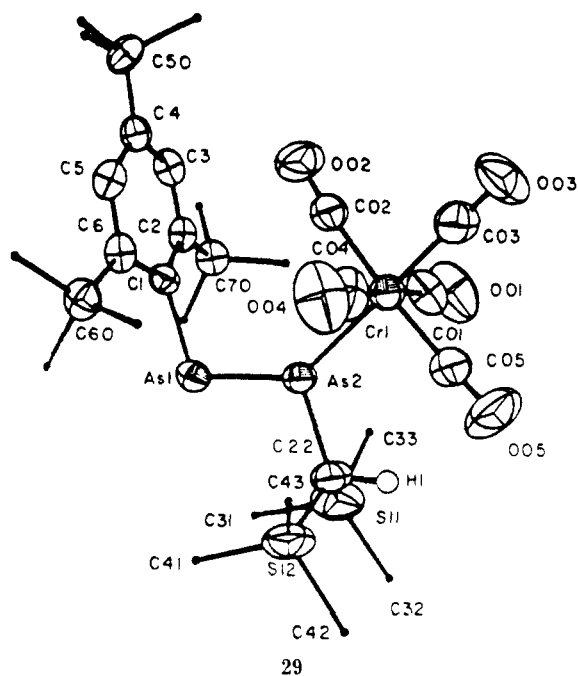

which the $\text{Cr}(\text{CO})_5$ group is terminally coordinated to the Si-substituted As atom.^{58,59} The As-As distance of 2.246 (1) Å is consistent with retention of the double bond but is slightly elongated in comparison to the uncoordinated ligand (2.224 (2) Å). As expected, the As atoms and all atoms bonded to As are coplanar. A very similar structure is found in $[(\text{Me}_3\text{Si})_2\text{CH}]_2(\text{As}=\text{As})[\text{Mo}(\text{CO})_5]$ (**30**), which has an extraordinarily short As-As distance (2.215 (1) Å); no atomic coordinates were published with this structure and the distance is unverified.^{60a} Fenske-Hall MO calculations on $\text{H}_2\text{P}_2\text{-}[\text{Cr}(\text{CO})_5]$ (modeling **24** and **30**) show that end-on coordination cannot be described as a pure σ - and π -donor

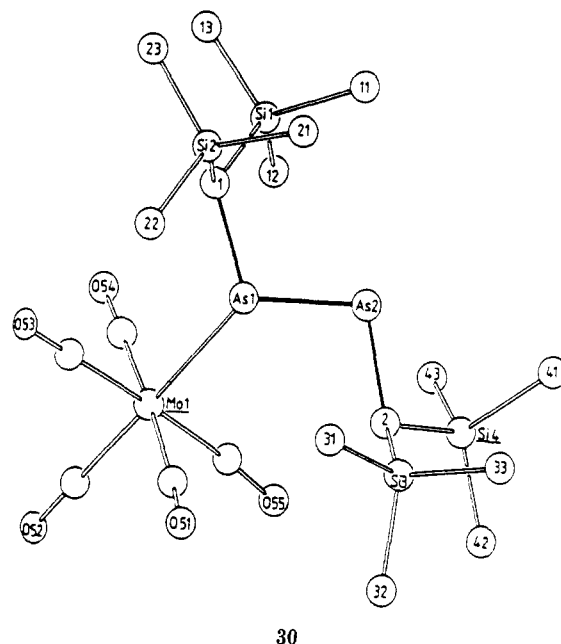

bond but that delocalized σ and π interactions also play an important role.^{60b}

Huttner and co-workers have shown that the diarsene structure can be synthesized (in situ) and further substituted, terminally (as in **29** and **30**) at both As atoms, or a 16-electron group can form a π -olefinic bond across the As=As bond. Thus, diphenyldiarsene (never itself isolated) can add three $\text{W}(\text{CO})_5$ groups to form $[(\text{CO})_5\text{W}]_2(\text{PhAs}=\text{AsPh})[\mu\text{-W}(\text{CO})_5]$ (**31**) in which the

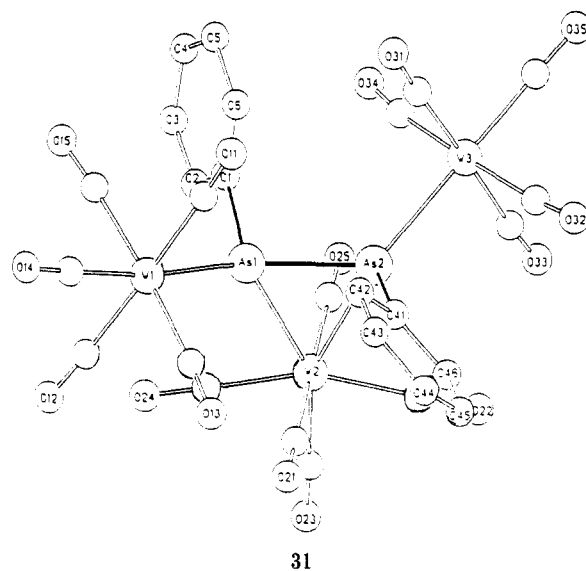

As-As distance (2.365 (6) Å) is greatly increased from the double bond range by the effects of π coordination.⁶⁰ As is true for all such structurally characterized diarsene complexes, the terminal substituents are in a trans arrangement. Similarly, a $\mu\text{-Fe}(\text{CO})_4$ group can replace the $\mu\text{-W}(\text{CO})_5$ group in **31** to form **32**, which also contains $\text{Cr}(\text{CO})_5$ groups in place of the terminal $\text{W}(\text{CO})_5$ groups, and in **33** a $\mu\text{-W}(\text{CO})_5$ group is present with only a single terminal $\text{W}(\text{CO})_5$ group.⁶⁰ Compounds **31** and **33** are formed from the reaction of $\text{Na}_2[\text{W}_2(\text{CO})_{10}]$ with PhAsCl_2 , and **32** is formed from $(\text{CO})_5\text{CrAsPhH}_2$ and $\text{Fe}_3(\text{CO})_{12}$. The As-As distances in **32** and **33** are similar to that found in **31**, 2.368 (6) and 2.342 (4) Å, respec-

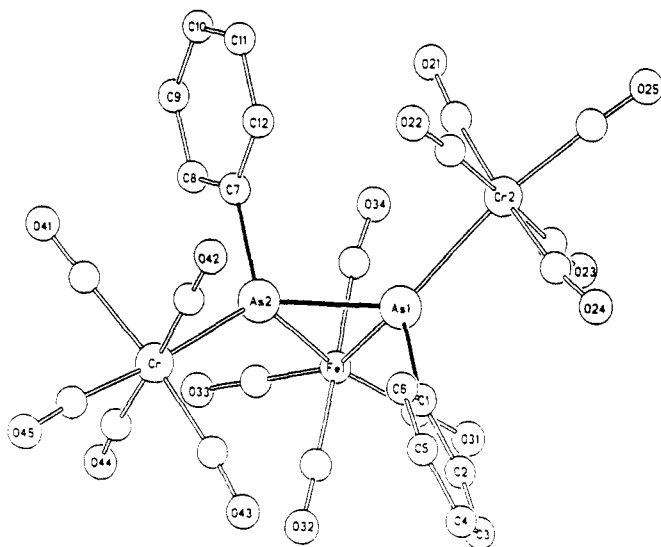

32

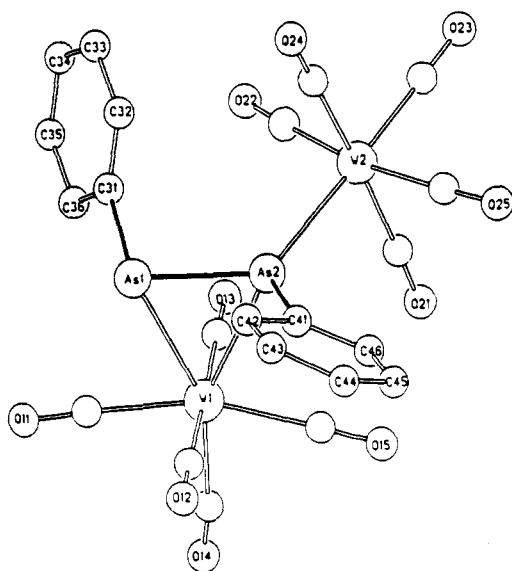

33

tively. Further substitutional possibilities can be envisioned from simple isolobal analogies. The μ -Fe(CO)₄ group can be replaced by L₂Pd (L = P(OEt)₃ (34) or 2L = bpy (35)).⁶¹ Both 34 and 35 are formed from [(CO)₅CrAs(H)Ph]₂ by the action of a Pd/C dehydrogenation catalyst in the presence of P(OEt)₃ or bipyridine.

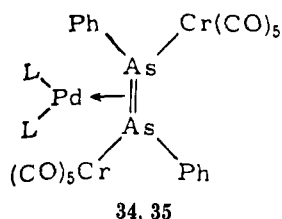

34, 35

IV. Complexes Containing Unsubstituted Arsenic Atoms

A. Tetrahedral Structures

An arsenic atom is the isolobal equivalent of a 15-electron organometallic fragment. Tetrahedral structures naturally arise from such fragments due to the

presence and position of three orbitals available for cluster building. The relationship among tetrahedrane, white phosphorus (and yellow arsenic), and Ir₄(CO)₁₂ will escape no modern chemist. If one begins with yellow arsenic as the basis for extrapolation, one, two, or three arsenic atoms can be replaced by 15-electron groups, e.g., CpMo(CO)₂ or Co(CO)₃. Whereas several extratetrahedral complexes of the intact P₄ structure have been reported,⁶ none of As₄ are known.

Dahl and co-workers found that the reaction of Co₂(CO)₈ and 2 at 200 °C in hexane under 100 atm of CO yielded a variety of products.^{62,63} From the mixture they were able to obtain crystals of Co(CO)₃(η³-As₃) (36). This 60-electron cluster (counting main-group

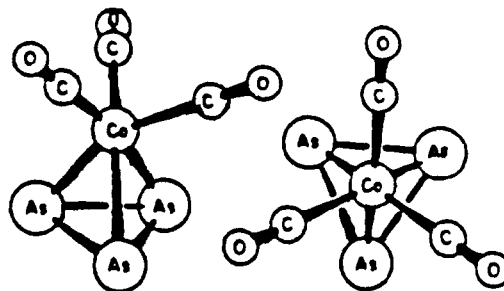

36

atoms by their periodic group number, i.e., 15 for As) is a clear tetrahedrane analogue. The molecule has threefold symmetry and therefore an equilateral As₃ base. The As-As distance is 2.372 (5) Å, which is considerably shorter than that found in yellow arsenic vapor (2.44 Å),⁶⁴ or in arsenic metal (2.516 (1) Å).⁹⁰ The shortening is attributed to a reduction in interarsenic repulsions by the introduction of the more electronegative Co(CO)₃ group and by direct lone pair-cobalt interaction.

The As-As bond becomes much shorter still in triphenylphosphine derivatives of [Co(CO)₃]₂(μ,η²-As₂); derivatization was required as the parent compound is a liquid. For the Co₂As₂ cluster [Co₂(CO)₅(PPh₃)]-(μ,η²-As₂) (37) and the bis-PPh₃ derivative 38, the As-As distances are 2.273 (3) and 2.281 (3) Å, respectively.^{63,65} While these values are longer (by ca. 0.05 Å) than the As-As double bonds found in the diarsene derivatives 29 and 30, they are well within a recognized double-bond region. The presence of a second metal-carbonyl vertex has further shortened the As-As bond. One extreme view of the As₂ group in 37 and 38 is to con-

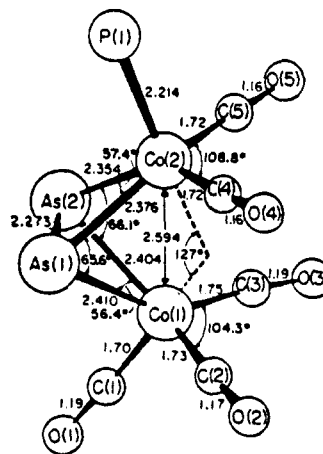

37

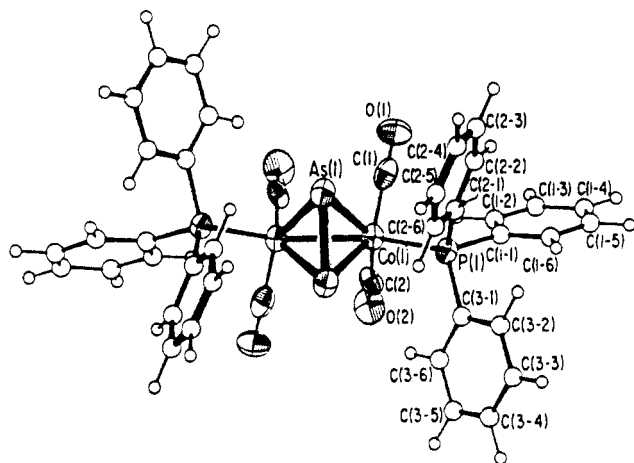

38

sider it an analogue of dinitrogen; on coordination, the triple bond in As_2 is reduced in bond order by $d-\pi^*$ back-donation from cobalt to As_2 and to a lesser extent by ligand-to-metal σ donation. The electronically related acetylene complex $\text{Co}_2(\text{CO})_6(\text{PhCCPh})$ has a C-C distance of 1.37 Å, at the long end of the C-C double-bond region.⁶⁶⁻⁶⁸

Wachter and co-workers have found that the reaction of the triply bonded dimer $[\text{Cp}^*\text{Mo}(\text{CO})_2]_2$ with As_4S_4 in toluene at 100 °C produces $[\text{Cp}^*\text{Mo}(\text{CO})](\eta^3-\text{As}_3)$ (**39**)

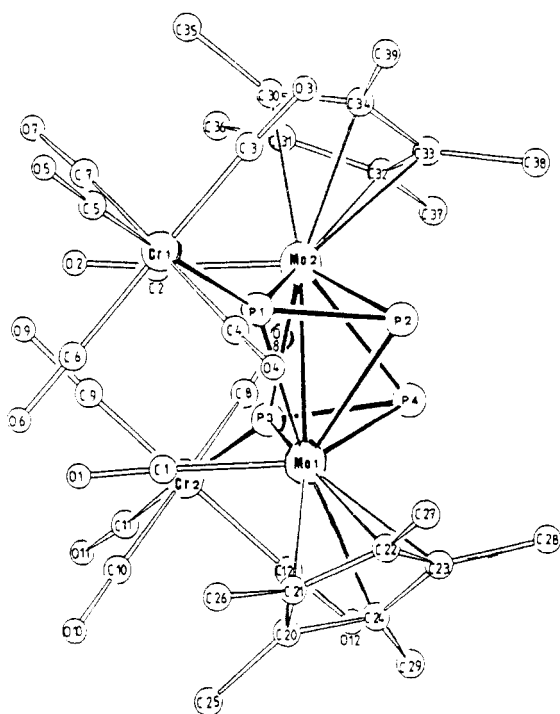

39

in low yield.⁶⁹ The $\text{Cp}^*\text{Mo}(\text{CO})_2$ group is electronically equivalent to $\text{Co}(\text{CO})_3$, and **39** is a direct analogue of **36**, the As-As distances (av 2.375 (2) Å) being the same as found in **36**.^{62,63} Scherer has also obtained compound **39**, also in low yield, from the direct reaction of $[\text{Cp}^*\text{Mo}(\text{CO})_2]_2$ with yellow arsenic.^{70,71} The Mo_2As_2 tetrahedrane analogue $[\text{CpMo}(\text{CO})_2]_2(\mu, \eta^2-\text{As}_2)$ (**40**) may be obtained from several sources: thermolysis of **19** at 160 °C produces good yields of **40** as well as the direct reaction of either **1** or **2** with $[\text{CpMo}(\text{CO})_3]_2$.⁷² The Cp^* analogue of **40** is a coproduct in the reaction used to

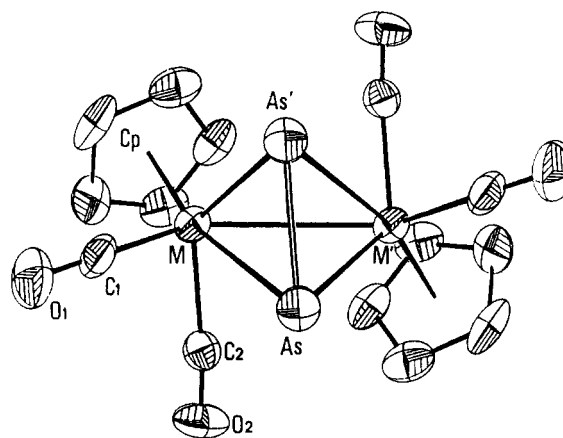

40, 41

prepare **39**.^{70,71} The As-As bond distance (2.311 (3) Å) in **40** is slightly longer than in **37** and **38**, which may be a reflection of either the lower electronegativity (nucleophilicity) of the $\text{CpMo}(\text{CO})_2$ group (compared to $\text{Co}(\text{CO})_3$) or the steric requirements of Cp substitution (or both). The Cp rings adopt a trans orientation. The tungsten analogue of **40**, $[\text{CpW}(\text{CO})_2]_2(\mu, \eta^2-\text{As}_2)$ (**41**), has been prepared from **1** and $\text{CpW}(\text{CO})_2\text{H}^{72}$ and also from $[\text{CpW}(\text{CO})_3]_2$ and arsenic metal (not yellow As).⁷¹ The As-As distance in **41** is nearly identical with that found in **40**.

The addition of higher stoichiometric amounts of **1** in the reaction used to prepare **40** leads to the formation of the bis- (μ, η^2) -diarsenic product $[\text{CpMo}(\text{CO})_2]_2(\mu, \eta^2-\text{As}_2)_2$ (**42**) by further decarbonylation.⁷³ This product

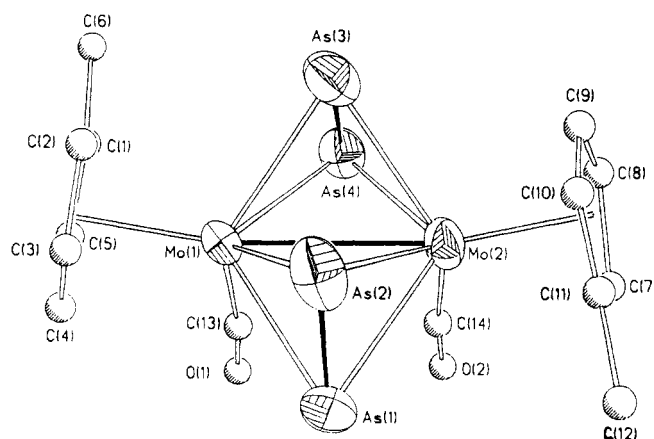

42

is analogous to a bis(acetylene) complex, which has been proposed as an intermediate in alkyne cyclooligomerization reactions⁷⁴ but has never been isolated. The two As_2 units are both nearly perpendicular to the Mo-Mo bond; their As-As distances (2.272 (2) and 2.281 (2) Å) are slightly shorter than in **40**, and the Mo-Mo distance (2.950 (1) Å) is considerably shorter than in **40** (3.039 (2) Å). Compound **42** may be viewed as two Mo_2As_2 tetrahedra sharing a common edge, i.e., the Mo-Mo bond.

The fate of the organic substituents in reactions of **1** or **2** in which naked As atoms are formed has been resolved by the frequent isolation of μ -arsenido (μ - R_2As) complexes along with the naked-atom species; the process is one of disproportionation; i.e., $2\text{RAs} \rightarrow \text{As} + \text{R}_2\text{As}$.¹³ Tetramethyldiarsine is consistently observed

in the ^1H NMR spectra of these reaction mixtures (1.09 ppm in C_6D_6).

B. Arsenic-Substituted Tetrahedral Complexes

The As_2 group in the M_2As_2 tetrahedrane analogues 40–42 serves as a four-electron donor; thus, further coordination of the As atoms is possible. From the reaction of $[\text{CpMo}(\text{CO})_2(\mu\text{-CO})\text{Cr}(\text{CO})_5](\mu_3\text{-As})[\text{Cr}(\text{CO})_5]$ with PPh_3 (which serves an agent for the removal of a $\text{Cr}(\text{CO})_5$ group), a derivative of 40 is obtained, $[\text{CpMo}(\text{CO})_2]_2(\mu, \eta^2\text{-As}_2)[\text{Cr}(\text{CO})_5]_2$ (43), in which

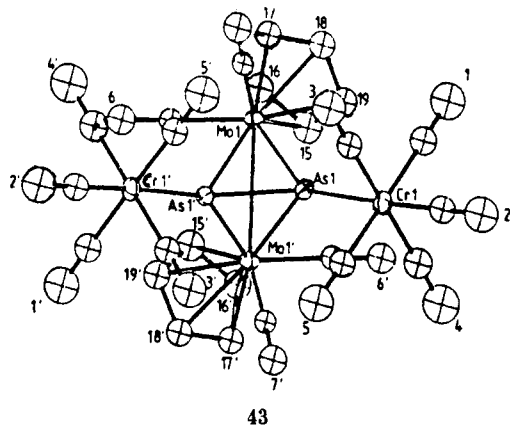

each As atom of 40 is additionally coordinated to a $\text{Cr}(\text{CO})_5$ group; overall, the As_2 ligand has increased its donation from four to eight electrons.⁵⁶ The presence of the $\text{Cr}(\text{CO})_5$ groups has little effect on the As-As distance (2.310 (3) Å) but slightly increases the Mo-Mo distance (3.064 (3) Å). The failure of the Mo-Mo bond to respond to the effects of coordination has been attributed to a balance between the opposing effects of reduced π -donor capability and increased π -acceptor qualities. The Cp rings remain in staggered positions on the side opposite to the As_2 group. The As_2 group in both 40 and 42 is slightly turned from perpendicularity (by 4–5°); Huttner and co-workers have attributed this to electronic effects, primarily due to second-order Jahn-Teller phenomena.⁵⁶ Furthermore, both complexes have nearly identical Cp-Mo-Mo-Cp torsion angles (75–79°) for which there is no apparent steric demand; this effect is also attributed to electronic effects. Curiously, in both 40 and 42 the two distances

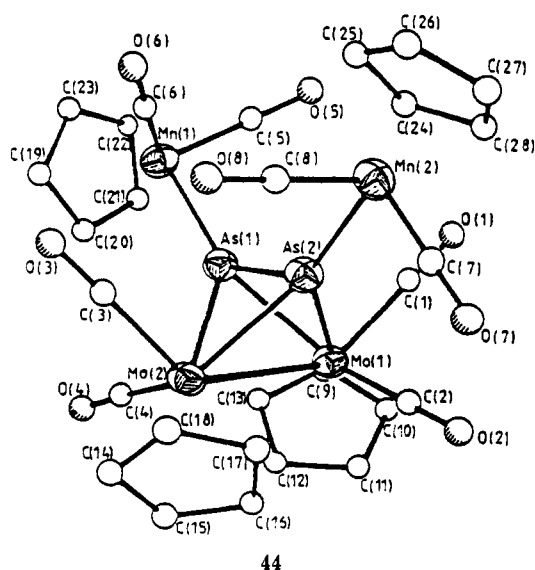

from Mo to the As atoms are significantly different (av Mo-As = 2.57 and 2.67 Å in 40, and 2.53 and 2.65 in 42); both are slightly shortened by the electron-attracting $\text{Cr}(\text{CO})_5$ group. The positions of the $\text{Cr}(\text{CO})_5$ groups in 42 indicate the locations of the free lone pairs on As; the As-As-Cr angle is 135°.

Similarly, Zeigler and co-workers have prepared an analogue of 42 in which the $\text{Cr}(\text{CO})_5$ groups have been replaced with isoelectronic $\text{CpMn}(\text{CO})_2$ groups, $[\text{CpMo}(\text{CO})_2]_2(\mu, \eta^2\text{-As}_2)[\text{CpMn}(\text{CO})_2]_2$ (44).⁷¹ All distances are similar to those found in 43. Compound 44 was prepared by treatment of 40 with $\text{CpMn}(\text{CO})_2(\text{thf})$.

The M_2As_2 tetrahedrane structure is also found with inequivalent metal groups. Treating $[\text{W}(\text{CO})_5]_3(\mu_3, \eta^2\text{-As}_2)$ (discussed below) with I_2 leads to the formation of $[\text{W}(\text{CO})_4(\mu, \eta^2\text{-As}_2)(\mu\text{-I})[\text{W}(\text{CO})_3\text{I}]$ (45), con-

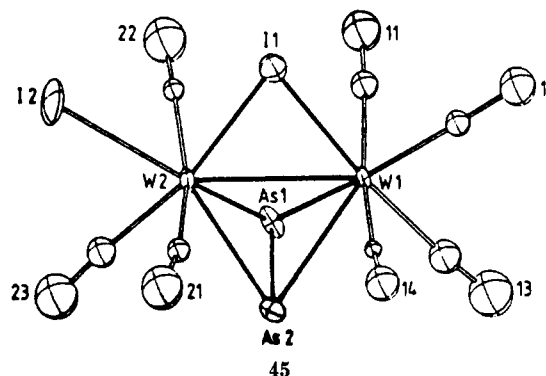

taining a $\mu\text{-I}$ bridge between the metal atoms.⁵⁶ Despite the asymmetric substitution, the M_2As_2 structure is very similar to that found in 41, although the As-W distances to W(2), which is in a higher oxidation state than W(1), are predictably shorter (av W(1)-As = 2.69 Å, W(2)-As = 2.62 Å). The distinctly different metal-As distances from one metal atom to the As atoms found in compounds 40–44 are missing in 45.

Müller and Vahrenkamp have prepared a further example of an As-substituted tetrahedral complex containing a Dahl-type (Co_2As_2) structure (see 37 and 38) by the reaction of $[\text{Co}(\text{CO})_3](\mu, \eta^2\text{-As}_2)$ with $\text{W}(\text{CO})_5(\text{thf})$ and characterized as the bis(triethyl phosphite) complex $\{\text{Co}(\text{CO})_2[\text{P}(\text{OEt})_3]_2(\mu, \eta^2\text{-As}_2)[\text{W}(\text{CO})_5]\}$ (46).⁷⁵ The As-As distance (2.28 (1) Å) is typical of such complexes.

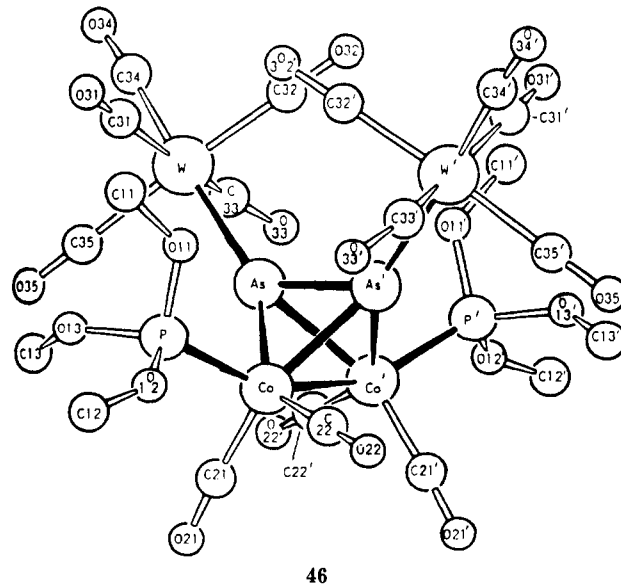

SCHEME I

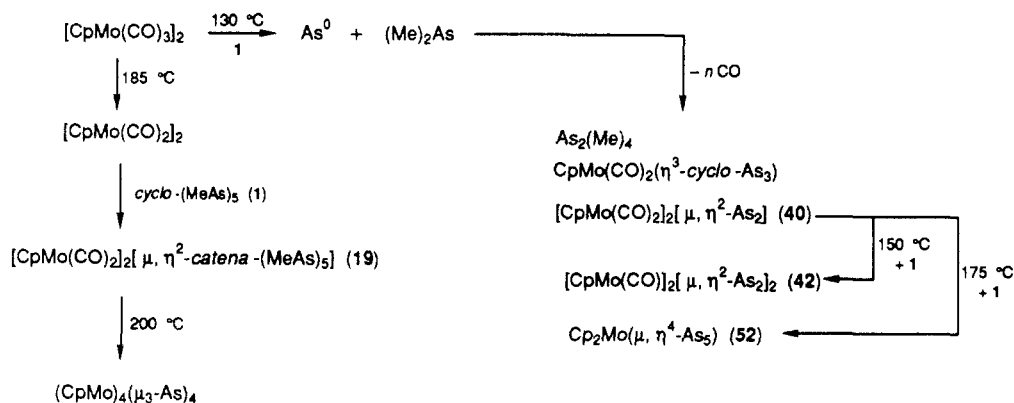

C. Incomplete Tetrahedral Structures

When $\text{CpMn}(\text{CO})_2$ replaces $\text{CpMo}(\text{CO})_2$ in **40**, a metal-metal bond is no longer necessary to fulfill an 18-electron count. Thus, from the thermolytic dehydrogenation of $[\text{Cp}^*\text{Mn}(\text{CO})_2]_2(\mu\text{-AsH})$ at 120–140 °C in vacuo, $[\text{Cp}^*\text{Mn}(\text{CO})_2]_2(\mu, \eta^2\text{-As}_2)$ (**47**) is obtained,

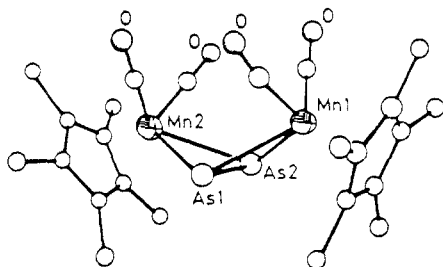

47

which may be described as an opened-tetrahedrane, butterfly structure with the two As_2Mn planes forming a dihedral angle of 121.8°. The As-As distance (2.225 Å) is unusually short in comparison to closed-tetrahedrane structures (As-As = ca. 2.3 Å). The As-As distance in **47** is more nearly in the accepted double-bond range typified by the diarsene structures. This leads to the conclusion that the As-As distance in closed-tetrahedrane structures must be somewhat elongated to accommodate formation of a tetrahedral structure. The preparative procedure leading to **47** is another example of the coupling of naked arsenic atoms from precursors with easily removable substituents.

Incomplete tetrahedron formation in an MA_3 structure is manifested in complexes containing a 15-

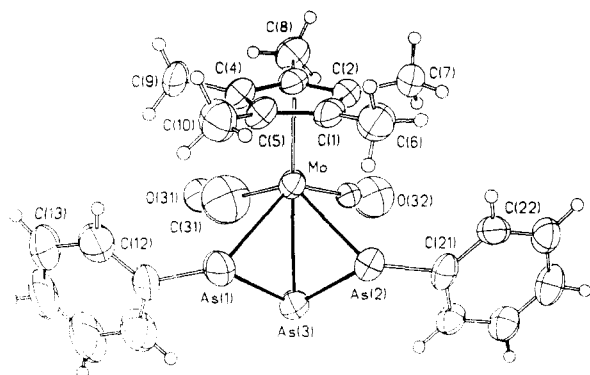

48

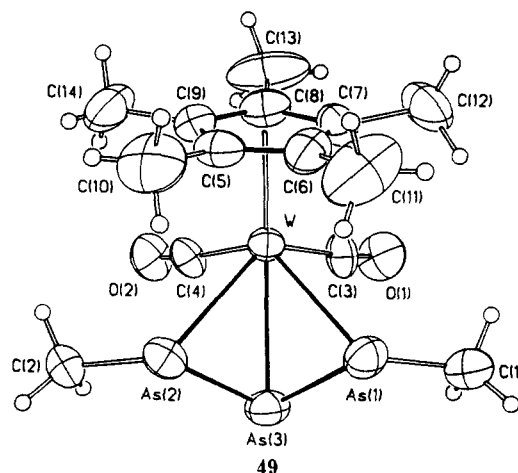

49

electron metal group and an allylic ($\eta^3\text{-RAs-As-AsR}$) group. The ability to form such structures appears to be dependent on the presence of a Cp^* group. Two such $[\text{Cp}^*\text{M}(\text{CO})_2](\eta^3\text{-RAs-As-AsR})$ complexes are known: **48** ($\text{M} = \text{W}$, $\text{R} = \text{Me}$) and **49** ($\text{M} = \text{Mo}$, $\text{R} = \text{Ph}$).⁷⁶ Both are formed directly from the triply bonded dicarbonyl dimers and either **1** or **2** under reaction conditions similar to those used to prepare the closed structures **40** and **41**. No evidence for the formation of the closed structures, analogous to **40** or **42**, was found in these Cp^* systems. Very low yields of the closed Cp^* complexes have been obtained in reactions of $[\text{Cp}^*\text{Mo}(\text{CO})_2]_2$ and either As_4S_4 ,⁶⁹ yellow arsenic,⁷⁰ or metallic arsenic.⁷¹ Recent evidence suggests that these limited yields may arise from traces of $[\text{Cp}^*\text{Mo}(\text{CO})_3]_2$ in the samples of $[\text{Cp}^*\text{Mo}(\text{CO})_2]_2$ (also see Scheme I).⁷⁷

Complexes **48** and **49** are the first examples of true π -allylic complexes in which there are no carbon atoms in the three-atom allylic group. The four As-As bonds in the two complexes are statistically identical (2.361 Å), a value intermediate between single- and double-bond distances, in keeping with delocalized bonding with a bond order of approximately 1.5. The As_3 group is endo with regard to the central As atom; all-carbon π -allyl-metal complexes are found in both endo and exo conformations.⁷⁸ Additional conformational isomerization is possible at the outer As atoms, but steric crowding allows only the exo,exo conformation shown. The dihedral angle formed by the As_2M planes in these structures is about 96°, a value very similar to that found in related all-carbon systems.⁷⁸

D. Dinuclear Complexes with Rings of Arsenic Atoms

An unsubstituted arsenic atom is also the isolobal equivalent of a CH group. CH fragments in organic chemistry form acetylene and the cyclooligomers $(CH)_n$. Thus, it is possible that As atoms will combine to form similar structures. Perhaps the most elegant demonstration of this comes from the same property of phosphorus atoms: Scherer has formed (pentaphosphacyclopentadienyl)(pentamethylcyclopentadienyl)iron (**50**) from white phosphorus and $[Cp^*Fe(CO)_2]_2$. The relationship between **50** and ferrocene is obvious.^{79,80}

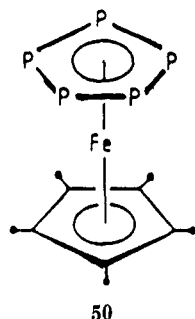

Sacconi and co-workers have further coordinated the As_3 plane in a $CoAs_3$ tetrahedral complex in which each of the metallic groups is (triphos)Co (triphos = $CH_3C(CH_2PPh_2)_3$) to form $\{[(triphos)Co]_2(\mu, \eta^3-cyclo-As_3)\}-(BPh_4)_2$ (**51**).^{81,82} Compound **51** is formed from the

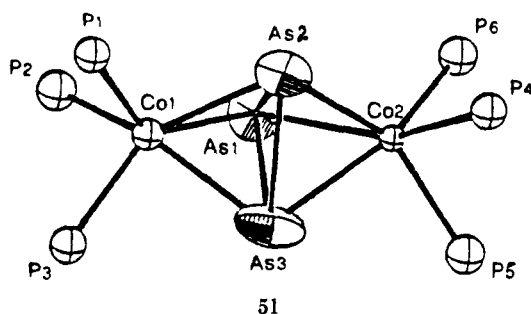

reaction of yellow arsenic and cobalt tetraphenylborate in the presence of triphos. The structural data for the cation of **51** are of low quality, but it is probable that the average As-As distance (2.42 (2) Å) reveals an elongation relative to the As-As distance in **36** (2.372 (5) Å) as would be expected if each As uses both lone pairs in cluster formation. As expected, **51** is paramagnetic with a room-temperature magnetic moment of 2.22 μ_B .

In reactions of *cyclo*-(MeAs)₅ (**1**) with $[CpMo(CO)_3]_2$, several products are possible, depending on reaction conditions (see Scheme I). If the reactants are rapidly heated to high temperatures (175–180 °C), decarbonylation precedes demethylation, and fully substituted chains of MeAs units (e.g., **19**) are formed. At lower temperatures, a significant amount of disproportionation of the MeAs units occurs with the formation of tetramethyldiarsine and elemental arsenic, and products containing unsubstituted As atoms are formed (e.g., **40** and **42**). A third possibility, that of Mo-Mo bond cleavage, is probably the path taken in forming $MoAs_5$ tetrahedra.

The progression from **40** to **42** represents the addition of a second molecule of the acetylenic diarsenic

“molecule”. Just as organic analogues of **42** have been proposed (but never isolated) as cyclooligomerization analogues,⁷⁴ **42** may be viewed as a precursor to cyclized As atoms. Thus, when samples of either **40** or **42** are heated in toluene for several days, there occurs a slow conversion to $(CpMo)_2(\mu, \eta^4-As_5)$ (**52**), which may be

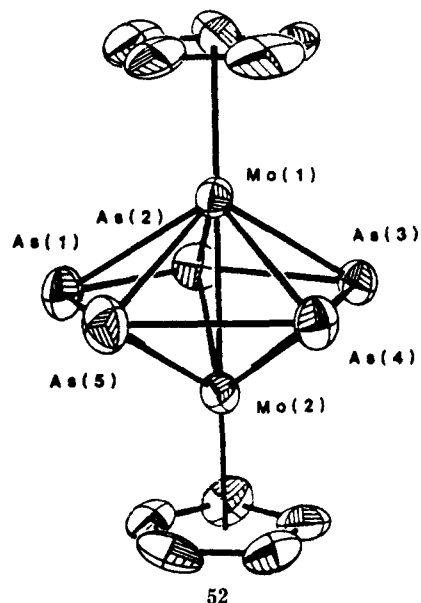

described as a 27-electron, triple-decker sandwich complex containing a planar ring of five As atoms.^{47b} The $C_5H_4CH_3$ analogue of **52**, which is more soluble than **52**, was found to have a magnetic moment of 1.32 μ_B as measured by the Evans method.⁴¹

The pattern of As-As bond distances in **52**, shown in **52a**, reveals an extreme distortion from regularity with some resemblance to a cyclopentadienyl-like “allyl-ene” system. As(5), As(1), and As(2) form the allylic portion

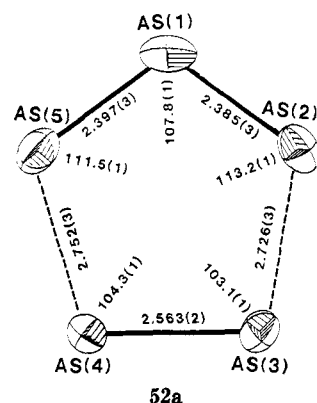

with As-As distances (av 2.391 (2) Å) significantly shorter than single-bond values. The As(3)-As(4) distance (2.563 (2) Å) is comparably longer than a normal single bond. The As(2)-As(3) and As(4)-As(5) distances (av 2.757 (3) Å) correspond to an approximate bond order of 0.5. The same pattern of distortion of the As_5 ring is repeated in both of two crystallographically independent molecules of **52**, which differ significantly only in the rotational alignments of the three rings of each molecule. The Mo-Mo distance is 2.764 (2) Å. Additionally, the Cp' analogue has also been prepared and the As_5 ring is identically distorted.

In the analogous *cyclo*-pentaphosphorus derivative from $[CpCr(CO)_3]_2$, $(CpCr)_2(\mu, \eta^5-cyclo-P_5)$,⁸³ the P_5 ring

is much more regular than found in **52** in its range of P–P distances. Both the As_5 and P_5 ring systems have been the subject of two recent theoretical studies that reach the same conclusions.⁸⁴ The distortions in the *cyclo-As₅* system arise from second-order Jahn–Teller effects. The differences between the P_5 and As_5 systems are produced by a much smaller energy range for the manifold of orbitals associated with the As_5 group (15 eV) as compared to that for P_5 (60 eV). The range is smaller for As due to the greater diffuseness of the As orbitals resulting in a smaller interatomic overlap. Interestingly, there is a better energy match and more mixing between the metal-based fragment orbitals and π^* and σ^* orbitals of the As_5 ring than for the P_5 ring. These prominent differences between phosphorus and arsenic structures should provide a message of caution to theoreticians who frequently substitute P for As in their calculations.

Several predictions about known and unknown compounds related to **52** stem from the MO calculations.^{84b} (1) The introduction of heteroatoms more electronegative than As in the As_5 ring should increase the distortion; compound **65** (see below) with an As_4S central “ring” is, in fact, distorted to the extent that it is better described as independent η^2-As_3 and η^2-AsS systems. (2) The all-Sb system will be even more distorted, and (3) reduction to the 28-electron radical anion of **52** should result in less distortion. The all-Sb analogue will be a difficult synthetic challenge, and reduction of **52** will require finding a soluble analogue as it has proved to be insoluble in all nondestructive solvents tested.

Recently, Scherer and co-workers have prepared the Cp' and $(\eta^5-C_5Me_4Et)$ chromium analogues to **52**, $[Cp'_2Cr_2(\mu, \eta^5-As_5)]$ (**53**) and $[(\eta^5-C_5Me_4Et)Cr]_2(\mu, \eta^5-$

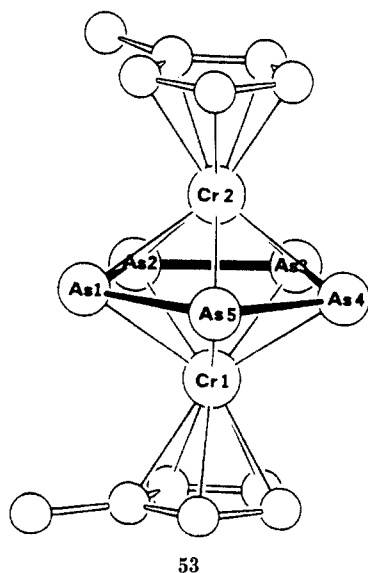

$As_5]$, from the respective Cr hexacarbonyl dimers and yellow arsenic in refluxing xylene.⁸⁵ The As_5 rings in both are considerably less distorted than in the Mo analogue; the range of As–As distances is only 2.40–2.44 Å. The Cr–Cr distance (2.776 (4) Å) is similar to that found for the Mo analogue. Since the presence of distortion in the As_5 ring in **52** was attributed to effects inherent in the energy spread for the manifold of As-based orbitals in **52** and since the manifold of metal-based orbitals is very similar for the $CpM \cdots MCp$ systems for Cr and Mo, the absence of distortion in **53**

appears to contradict the results of the calculations.^{84b} Via a similar preparative route, Scherer has also recently prepared a triple-decker hexaarsabenzene complex with tetramethylethyl Cp substitution, $[(C_5Me_4EtMo)_2(\mu, \eta^6-As_6)]$ ⁸⁶ (**54**), containing a planar As_6

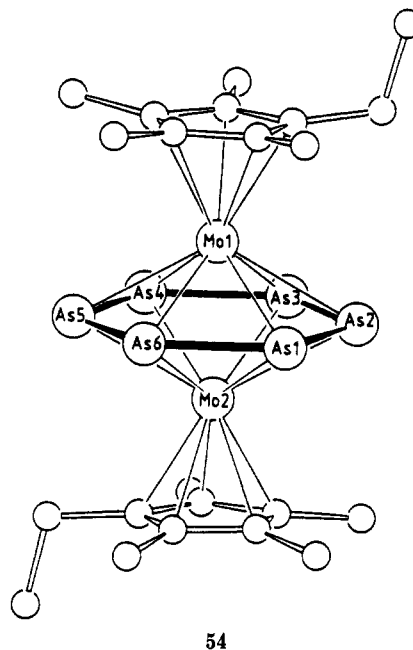

ring coplanar with the two Cp rings.⁸⁶ The As_6 ring in this 28-electron complex has identical As–As distances (av 2.35 Å) within experimental error and an Mo–Mo distance (2.639 (1) Å) that is considerably shorter than found in **52**. As the ring size expands and As–metal distances remain unchanged, shortening of the metal–metal vector is inevitable. The average As–As distance is midway between single- and double-bond values, in keeping with the obvious benzene analogy.

In the progressive decarbonylation sequence **40** to **42** to **52**, the Mo–Mo bond shortens from 3.039 (2) Å in **40**, to 2.950 (1) Å in **42**, to 2.764 (2) Å in **52** and the Cp rings change from a trans orientation in **40** to an almost exactly coplanar orientation (perpendicular to the Mo–Mo bond) in **42** and **52** (Scheme I). If the Cp rings are forced into a cis arrangement and the movement of the

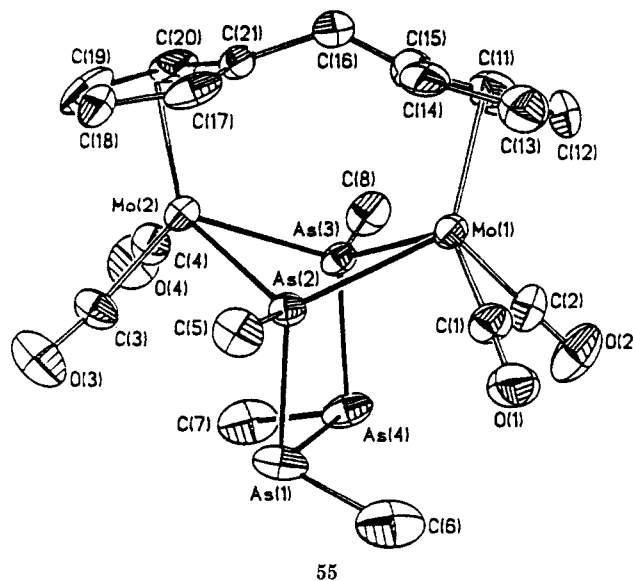

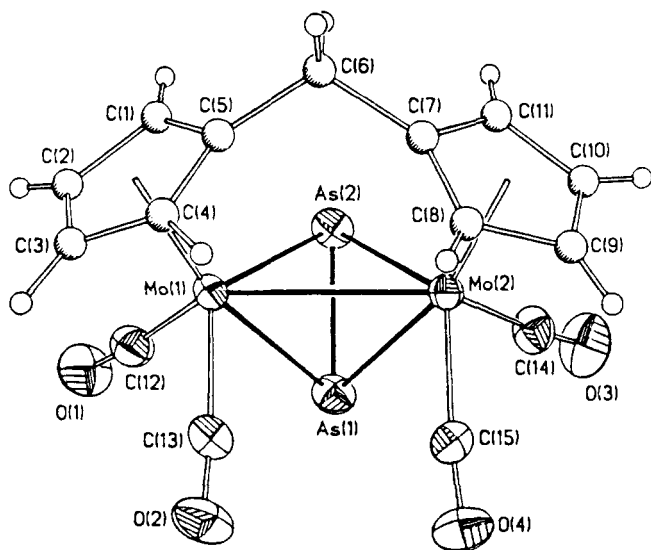

56

Cp rings is restricted by the introduction of a CH₂ bridge between them, then only an analogue of 40 is found; therefore, the inability of the Cp rings to adopt a coplanar arrangement restricts further reaction. From the reaction of [CH₂(C₅H₄)₂Mo₂(CO)₆] with 1, both the catenated MeAs chain complex {[CH₂(C₅H₄)₂Mo₂(CO)₄]-catena-(μ,η²-MeAs)₄} (55) (the product analogous to 19) and {[CH₂(C₅H₄)₂Mo₂(CO)₄](μ,η⁵-As₂)} (56) (the product analogous to 40) are formed.⁸⁷ The differences in reaction conditions that favor formation of either 55 or 56 are similar to the differences between 19 and 40; higher temperatures, where thermal decarbonylation is faster than demethylation, favor retention of organic substitution. Attempts to convert 56 to a bis(diarsenic) structure analogous to 41 failed due to the inability of the Cp rings to become coplanar. Thus, 56 is thermally stable to 220 °C, whereas 40 rearranges to 41 (and other products) at ca. 150 °C.

The tetramer chain length in 55 is one unit shorter than in 19, and the As(2)⋯As(3) separation is quite short (2.748(2) Å) compared to the nonbonded separation in 19 (2.835(2) Å). Additionally, the Mo⋯Mo separation in 55 (4.062(1) Å) is shorter than in 19 (4.169(1) Å). These effects are directly attributable to the presence of the methylene bridge and the constraints imposed on the locations of the Cp rings, which are in 55, by necessity, in a cis conformation. The bonded As-As distances in 55 are normal (av 2.440(2) Å). The effects of methylene bridging in 56 (compared to its unbridged analogue 40) are less extensive; the Mo-Mo distance in 56 is only 0.02 Å longer than in 40 and the As-As distances are identical.

Reactions of Co₂(CO)₈ and other Co complexes with various arsenic reagents usually result at high temperatures (>200 °C) in the formation of CoAs₃ and Co₂As₂ tetrahedral clusters (e.g., 36). However, at room temperature, very large clusters are formed that, at least in part, may be viewed as assemblages of Co-As tetrahedra.⁸⁸ Although not experimentally verified, it may be presumed that these large clusters of clusters decompose to simple tetrahedra at high temperatures. The room-temperature reaction of [CoCl₂(PPh₃)₂] with PhAs(SiMe₃)₂ produces [Co₄(μ₃-As)₃(μ₃,η³-As₂)(PPh₃)₄] (57), which, in addition to recognizable tetrahedral fragments, contains a Co₃As₃ octahedron with a triangle

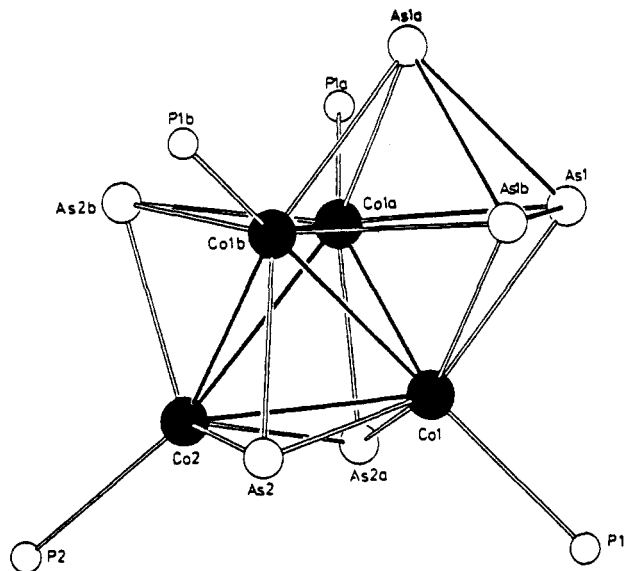

57

of As atoms (As-As = 2.463(1) Å).⁸⁹ This distance is comparable to the As-As distance in 2 (As-As = 2.459(1) Å) and in As metal (As-As = 2.516(1) Å)⁹⁰ but is considerably longer than that found in 36 (2.372(5) Å). The shortening of the As-As bonds in 36 (compared to As metal) is explained by an increase in bonding and a decrease in antibonding interactions within the As₃ ring.

Another complex with a triangle of As atoms (which might have been more appropriately classified as a substituted-As complex) is [Cr(CO)₅(CH₃C(CH₂As)₃)] (58), which is formed from the reaction of CH₃C(CH₂-

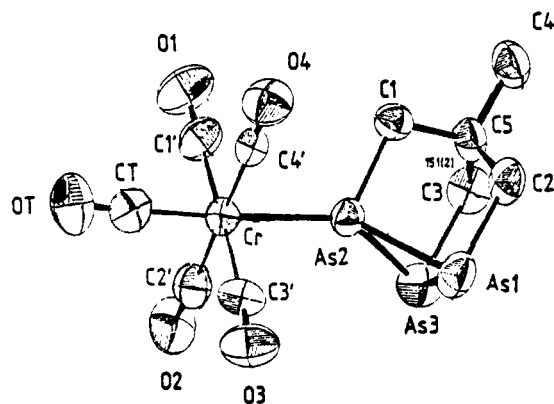

58

As)₃ with Cr(CO)₆.⁹¹ This complex is an unusual example of a ring of arsenic atoms functioning as a monodentate ligand. The As-As distances (av 2.407(2) Å) to the uniquely coordinated As atom are longer than in 36 and shorter than in 57, and the unique As-As bond distance (2.462(2) Å) is similar to that in 57 (and to normal single-bond values).

The coordinatively versatile As₂ ligand, discussed above in examples of tetrahedral structures, both with and without additional coordination, is also found in an unusual "wheel" framework in [W(CO)₅]₃(μ₃,η²-As₂) (59) prepared by Huttner and co-workers by the reaction of AsCl₃ with either Na₂W₂(CO)₁₀ or W(CO)₅(thf).^{56,92} The As-As distance (2.279(4) Å) is typical of As₂ complexes. In this case As₂ serves as a six-electron donor; to act as a six-electron donor, As₂ uses its

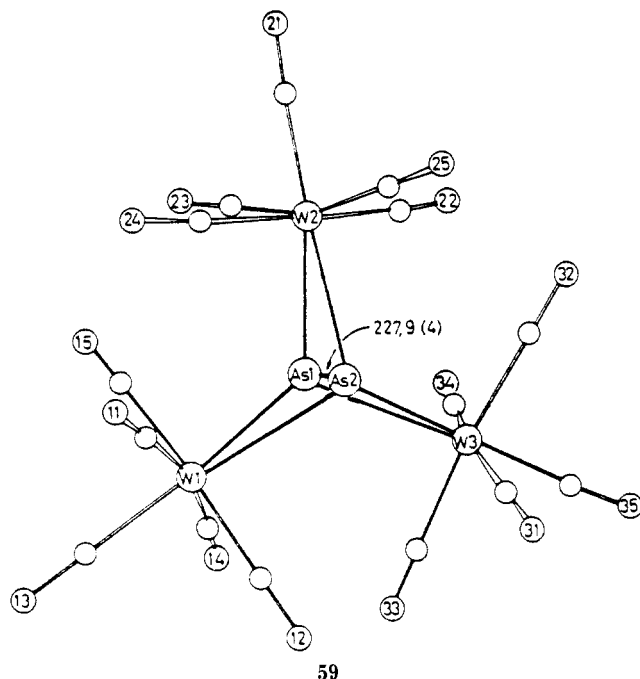

4π electrons plus 2σ electrons as donor electrons. These conclusions are supported by MO calculations.⁵⁶

V. Complexes of Arsenic Rings Containing Chalcogen Heteroatoms

The substitution of a chalcogen atom for arsenic in As_3 (forming As_2E ($E = S, Se, \text{ or } Te$), which is an isobal analogue of cyclopropene) has also proved a versatile ligand in the hands of Stoppioni and co-workers. The As_2E ligand may coordinate in a variety of modes: η^3 -monodentate, μ, η^2 -bidentate, or μ, η^3 -tridentate. The first mode is represented by three complexes identical except for E ($E = S$ (**60**),⁹³ Se (**61**), and Te (**62**)⁹⁴) pre-

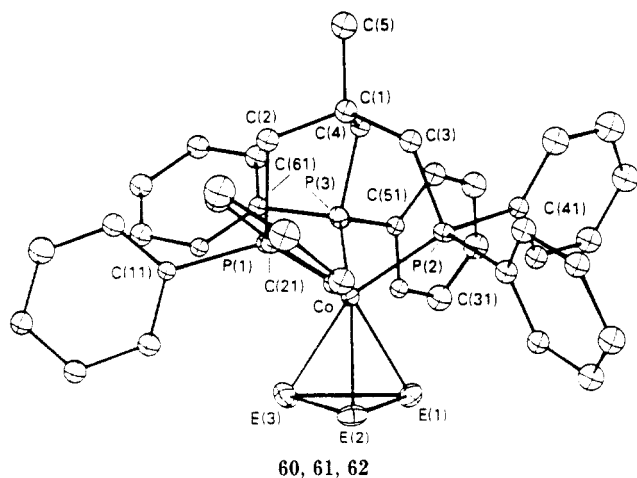

60, 61, 62

pared by the reaction of $Co(H_2O)_6(BF_4)_2$ with As_4E_3 in the presence of triphos to form $[(\text{triphos})Co(As_2E)](BF_4)$. In both **60** and **61** the As_2E plane is rotationally disordered, and the atoms refined as As/E composites of varying occupancies, rendering the distances of uncertain interpretation. The Te derivative **62** (differently lattice solvated) was ordered; the As-As distance (2.408 (5) Å) is typical of three-membered all-As rings, although somewhat longer than in $Co(CO)_3As_3$ (**36**). The presence of the heteroatoms apparently has no effect on the As-As distance.

Reaction of **60** with $(C_2H_4)Pt(PPh_3)_3$ involves insertion of the $Pt(PPh_3)_2$ group into a bond of the inorganic ring to produce $[(\text{triphos})Co(\mu, \eta^2-As_2S)Pt(PPh_3)_2](BPh_4)$ (**63**) (after addition of $NaBPh_4$).⁹⁵ Complex **63**

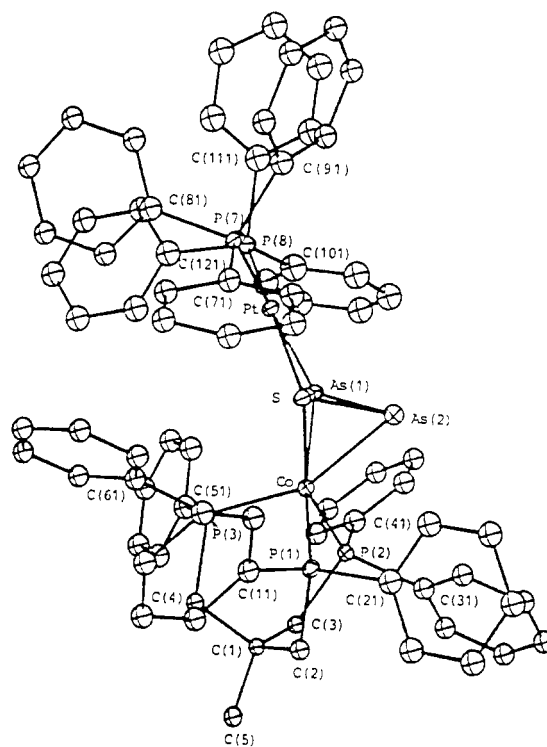

63

contains the As_2E ring in a μ, η^2 -bidentate coordination mode. The Co environments of **60** and **63** are essentially the same. As was true in both **61** and **62** the As_2S ring is disordered. As(2) was found to be exclusively As, but S and As(1) are almost equal S/As composites; As(1) is 56% As. The As(1)-S distance (3.03 (1) Å), surely affected to some extent by the disorder, is still unquestionably indicative of complete bond rupture on further coordination. The insertion in a heterobond (rather than As-As bond) is confirmed by ^{31}P NMR data for the P_2S analogue. The Pt atom environment is nearly square planar.

Similarly, treatment of **60** and **61** with the Rh(I) dimeric complex $[RhCl(\text{cod})]_2$ in the presence of triphos leads to additional metal complexation and replacement

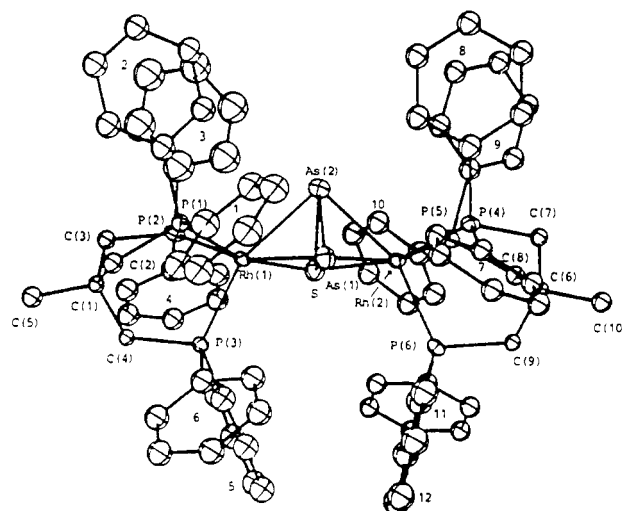

64, 65

of the Co(triphos) group to form a new complex containing the As_2E ring in a μ, η^3 coordination mode, $[(triphos)Rh]_2(\mu, \eta^2-As_2E)(BPh_4)_2$ ($E = S$ (**64**)⁹⁶ and Se (**65**)⁹⁷). Again, in both cases, the As and E atoms are disordered, but it does appear certain (from other evidence as well) that rupture of a heteroatom bond has occurred; the As(1)-S bond in **64** is 3.099 (6) Å. The overall structure of the cation is that of a triple-decker sandwich with a 32-electron count. Stoppioni and co-workers have used Wade's rules to show that the Rh_2-As_2E arrangement corresponds to the *nido* octahedral-derived structure expected for a cluster of five atoms with seven skeletal bonding electron pairs. The ring-opening distortion is supported by extended-Hückel calculations but could not fully distinguish between opening of an As-As or an As-S bond. Note also that the ring has shifted off of the Rh...Rh vector (3.750 (3) Å) and the Rh(triphos) groups are tilted away from the ring; both effects are also supported by the calculations.

Mixing *cyclo-S₈* and **1** in the presence of $Mo(CO)_6$ is an effective process for forming the heterocyclic rings $(CH_3AsS)_n$ ($n = 3$ or 4) in high yield.⁹⁸ Neither of these rings has been successfully coordinated to a metal carbonyl moiety, but in the process of forming the heterocycles, an $Mo(CO)_3$ complex of the nine-membered ring *cyclo-[(CH₃As)₆S₃]* was obtained, $[Mo(CO)_3][\eta^3-cyclo-(CH_3As)_6S_3]$ (**66**). As was also true for

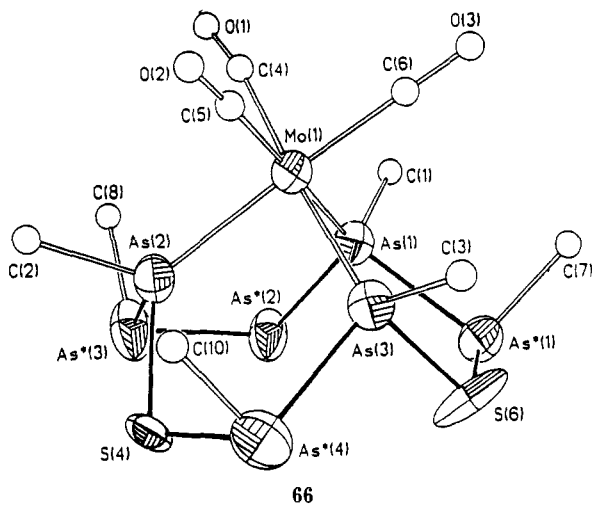

many of the As-S species described above, crystallographic As/S disorder was found in the six uncoordinated ring atoms; however, the As_6S_3 composition of the ring was verified by mass spectrometry. The As and S identities in the figure represent the majority composition. The As* positions are the majority sites; the companion S sites were not collocated and are not shown. The ring adopts the boat-chair conformation of cyclononane,⁹⁹ with which it is isolobally related.

Although the *cyclo-(CH₃AsS)_n* heterocycles do not themselves act as intact ligands, they do make interesting synthetic reagents, given their resemblance to the inorganic As/S species⁹⁹ used in the preparation of both homoarsenic and heteroarsenic ligands (see **39**). In this regard, the use of *cyclo-(CH₃AsS)₃* in reactions of $[CpMo(CO)_3]_2$ produces in low yield (among other products) a triple-decker sandwich structure $(CpMo)_2(\mu, \eta^3-As_3)(\mu, \eta^2-AsS)$ (**67**) in which the central deck is composed of an allylic As_3 group and an As-S

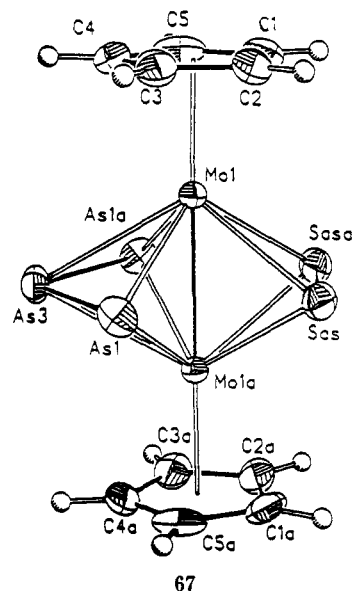

group.⁹⁸ The As_4S atoms are almost exactly coplanar. As seems to be the "curse" of these heteroatom complexes, the As-S group is disordered around a crystallographic twofold axis (these atoms are labeled Sas). The overall structure bears a strong resemblance to the pentaarsenic triple-decker **52**; **52** is a 27-electron paramagnetic cluster, whereas the addition of an S atom has increased the electron count by one in **67**, which is diamagnetic. (The very low solubility of both **52** and **67** in suitable solvents has prevented determining whether the 27- and 28-electron structures may be electrochemically interconverted.)

As was true in **52**, the three-atom As group in **67** is primarily coordinated through the 1- and 3-positions (As(1) and As(1a)) with a long Mo-As distance (av 2.744 (1) Å) to the central As atom compared to the Mo-As distance (2.374 (1) Å) is about 0.02 Å shorter in **67** than in **52** and, in keeping with a partial delocalization in the As_3 group, is about 0.1 Å shorter than a normal single-bond value. The Mo-Mo distance, already very short (2.764 (2) Å) in **52**, is shorter still in **67** (2.683 (1) Å). The two middle-deck atom groups are widely separated (2.961 (2) Å), suggesting, at best, a very weak interaction. According to Hoffmann's theoretical predictions, introducing a more electronegative heteroatom in the As_5 ring should lead to distortions of the kind seen; i.e., the ring should become more fragmented.⁸⁷

VI. Miscellaneous Complexes

The prolonged thermolysis (150 °C, 65 h) of $[\eta^6-cyclo-(PhAs)_9][Mo_2(CO)_9]$ (**9**) or of $[\eta^4-catena-(PhAs)_9][Mo_2(CO)_6]$ (**20**) (160 °C, 100 h) produces the unusual and extensively rearranged new complex $\{[Mo(CO)_4]_2(\mu-Ph_2AsAsPh)(\mu-Ph_2As)\}$ (**68**) in good yield (23%) along with other, intractable products.¹⁰⁰ This compound is frequently isolated from prolonged thermolyses, which suggests that it is very stable to further rearrangement. Complex **68** has the basic structure of a bis(μ -diphenylarsenido) $Mo_2(CO)_8$ complex, but one of the bridging Ph_2As groups has been replaced by a $\mu, \eta^1-Ph_2AsAsPh$ group. There appears to be no precedent for any pnictogen analogue of **68**. The extent of rearrangement ($Mo(CO)_3$ groups become $Mo(CO)_4$

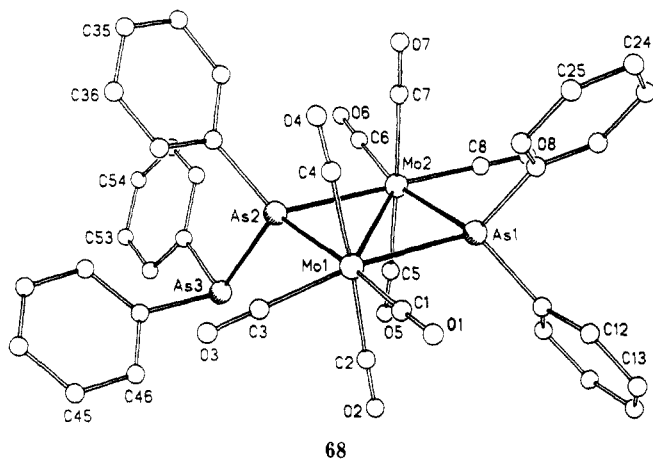

and one As becomes disubstituted) makes it difficult to trace the pathway for the formation of **68**. The Mo_2As_2 rhombus is nearly flat; the "wing" dihedral angle (2°) is identical with that found in **20**. The Mo-Mo distance (3.108 (2) Å) is also very similar. The As-As distance (2.427 (1) Å) is slightly shorter than a normal As-As single bond, suggesting that As(2) lone-pair involvement in forming the metal bridge may reduce lone-pair, lone-pair repulsion across the As-As bond.

In a bizarre reaction involving the niobium reaction vessel and an accidental overdose of rubidium in a reaction designed to prepare Rb_3As_7 , von Schnering isolated and crystallographically characterized $[\text{Rb}\{2,2,2\text{-crypt}\}]_2[\text{Rb}\{\text{NbAs}_8\}]$ (**69**) after treatment of the solution,

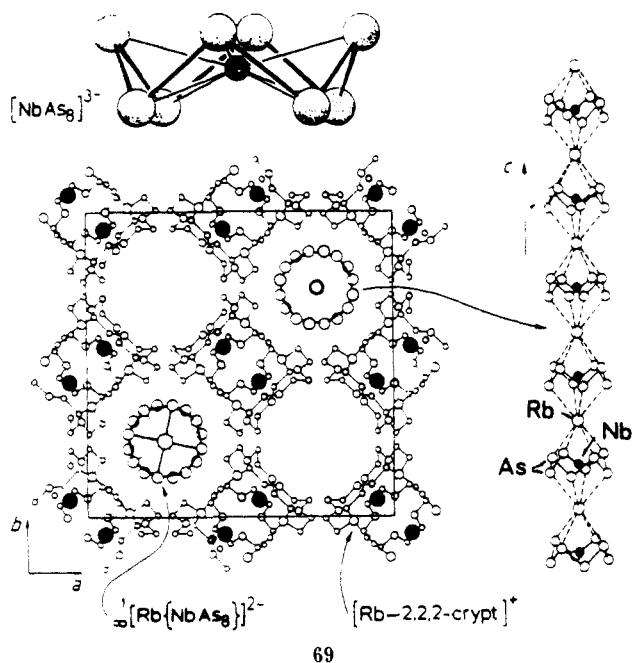

initially containing helical chains of As^- units, with 2,2,2-crypt and ethylenediamine.¹⁰¹ The η^8 -*cyclo*-octa-arsenidoniobate(V) trianion $[\text{NbAs}_8]^{3-}$ present in the chain has D_{4d} symmetry and consists of a monocyclic, crown-shaped polyanion (As^-)₈ with a Nb(V) ion in the center. The *cyclo*-(As^-)₈ ion is both isostructural and isoelectronic with *cyclo*- S_8 . The As-As distance (2.434 Å) is surprisingly similar to other As-As distances; the presence of additional charge in the ring apparently has little effect on the bond distance. It is also unusual that the donor function of the ring is directed inward, in

contrast to precedent. There is additional donor function shown in the association of a third Rb ion with the formation of one-dimensional chains (Rb-As = 3.92 Å). von Schnering has provided INDO calculations on the complex (V replacing Nb and K replacing Rb); the results indicate that the electronic states of the As_8 crown can be described almost exclusively in terms of pure 4s and 4p atomic orbitals, the latter forming the σ bonds along with the 4p π states of the lone pairs.

Compound **69** eloquently illustrates that a much more extensive study of the transition-metal chemistry of the anionic group 15 Zintl ion phases would be very rewarding. The use of Zintl ions as reactants introduces the main-group elements in an activated state, and as shown in **69** offers the opportunity to initiate synthesis from main-group clusters, the opposite approach to the synthesis of the majority of compounds discussed in this review.

VII. Concluding Comments

The ability of arsenic, in a broad and diverse range of chemical forms, to form homoatomic concatenations, while retaining lone pairs of electrons for further bonding, ensures a rich and structurally complex transition-metal chemistry for these materials. This review has presented the beginning of this field; the high level of activity currently seen in this field may be measured by the very high percentage of the references to structures from the past 5 years. Each of the synthetic precursors has shown an accommodating spectrum of properties. *cyclo*-Polyarsines have proved a particularly willing reagent. By manipulation of conditions, di-organoarsenido groups, rings and chains of RAs of two to ten units, and naked arsenic groups of two to five atoms have so far been formed. Numerous examples are also given for the in situ formation of polyarsenic species from monoarsenic precursors. In its most stable allotropic form, arsenic is notably unreactive; activation by the formation of yellow arsenic (ca. 550–600 °C) may be easily achieved, but this allotrope is inconvenient due to its extreme photolytic instability. Generation of naked arsenic may also be achieved by the thermal decomposition of arsine, and commercial units are now available as outgrowths of GaAs semiconductor production.

Isolobal analogue relationships¹⁰² have proved a powerful tool for organizing disparate structures. For arsenic-rich structures these relationships usually lead to structures with well-known main-group analogues (or simple extrapolations from them, e.g., tetrakis-homocubane); for metal-rich structures the arsenic atoms become cluster building blocks in structures tending toward *closo* limits. Many more examples of the metal-rich structures are now known, but as the resurgence in interest in main-group chemistry continues to develop, the number of main-group-rich structures will rapidly grow. Isolobal relationships have also very pointedly illustrated the coordination abilities of analogue structures. The analogy between As_2 and acetylene provides, from an unlikely source, conformation of speculative intermediates in alkyne oligomerization reactions. Several of the ring and chain products have a real resemblance to "fly-over bridge" structures¹⁰³ that may be produced in the terminal stages of dinuclear cyclooligomerization reactions.

Note Added in Proof. Photolysis of $[\text{Cp}^*\text{Nb}(\text{CO})_4]$ and yellow arsenic gives $[\text{Cp}^*(\text{CO})_2\text{Nb}(\eta^4\text{-As}_4)]$ as well as $[\{\text{Cp}^*(\text{CO})\text{Nb}\}_2(\text{As}_2)_2]$. The structure of the $\eta^4\text{-As}_4$ complex reveals a planar *cyclo*- As_4 "tetraarsacyclobutadiene" ligand with an average As-As distance of 2.38 Å. The heavy atoms form a square-pyramidal cluster.¹⁰⁴ A distorted cubane cluster, $[(\text{Cp}^*\text{Ni})_3(\mu_3\text{-As})(\text{As}_4)]$, is reported containing a tripodal As_4 group obtained from opening three of the six edges of yellow arsenic, and was obtained from $[\text{Cp}^*\text{Ni}(\text{CO})_2]$ and As_4 at 120 °C.¹⁰⁵

Acknowledgments. This research was supported in part by the donors of the Petroleum Research Fund, administered by the American Chemical Society, and the University of Delaware Center for Catalytic Science and Technology. We also thank Cynthia Baldacchini and Margaret Chandler for their assistance in the preparation of the manuscript. Prof. Thomas Bitterwolf's assistance in the preparation of 55 and 56 and frequent participation in group discussions is warmly acknowledged.

References

- Whitmire, K. H. *J. Coord. Chem., B* 1988, 17, 95.
- Herrmann, W. A. *Angew. Chem., Int. Ed. Engl.* 1986, 25, 56.
- Huttner, G.; Evertz, K. *Acc. Chem. Res.* 1986, 19, 406.
- Huttner, G.; Knoll, K. *Angew. Chem., Int. Ed. Engl.* 1987, 26, 743.
- DiVaira, M.; Stoppioni, P.; Peruzzini, M. *Polyhedron* 1987, 6, 351.
- DiVaira, M.; Sacconi, L. *Angew. Chem., Int. Ed. Engl.* 1982, 21, 330.
- Huttner, G. *Pure Appl. Chem.* 1986, 58, 585.
- (a) Scherer, O. J. *Angew. Chem., Int. Ed. Engl.* 1985, 24, 924. (b) Haiduc, I.; Sowerby, D. B. In *The Chemistry of Inorganic Homo- and Heterocycles*; Haiduc, I., Sowerby, D. B., Eds.; Academic: London, 1987; Vol. 2, p 701.
- Rheingold, A. L. In *Homoatomic Rings, Chains and Macromolecules of the Main-Group Elements*; Rheingold, A. L., Ed.; Elsevier: Amsterdam, 1977; p 385.
- West, B. O. In *Homoatomic Rings, Chains and Macromolecules of the Main-Group Elements*; Rheingold, A. L., Ed.; Elsevier: Amsterdam, 1977; p 409.
- (a) All crystallographically characterized complexes fitting these criteria found in searches of the Cambridge Crystallographic Database and *Chemical Abstracts* are included. Coverage is complete through 1988; partial coverage of 1989 is also included. (b) In about 10% of the structures, significant discrepancies were found in the reported data. Where these problems could not be resolved by comparison to the Cambridge files, structures were omitted. Two structures fell into this last group.
- Smith, L. R.; Mills, J. L. *J. Organomet. Chem.* 1975, 84, 1.
- Knoll, F.; Marsmann, H. C.; VanWazer, J. R. *J. Am. Chem. Soc.* 1969, 91, 4986.
- Elmes, P. S.; Middleton, S.; West, B. O. *Aust. J. Chem.* 1970, 23, 1559.
- Watkins, C. L.; Krannick, L. K.; Sisler, H. H. *Inorg. Chem.* 1969, 8, 385.
- Wells, E. J.; Ferguson, R. C.; Hallett, J. G.; Peterson, L. K. *Can. J. Chem.* 1968, 46, 2733.
- Elmes, P. S.; Gatehouse, B. M.; Lloyd, D. J.; West, B. O. *J. Chem. Soc., Chem. Commun.* 1974, 953.
- Rheingold, A. L.; Fountain, M. L.; DiMaio, A.-J. *J. Am. Chem. Soc.* 1987, 109, 141.
- Underwood, G. R.; Ramamoorthy, B. *Tetrahedron Lett.* 1970, 4125. This structure is sometimes also called UFOsane (see ref 21).
- Baudler, M. *Angew. Chem., Int. Ed. Engl.* 1987, 26, 419.
- von Schnering, H.-G. *Angew. Chem., Int. Ed. Engl.* 1981, 20, 33.
- von Schnering, H.-G.; Hönle, W. *Chem. Rev.* 1988, 88, 243.
- Haushalter, R. C.; Eichhorn, B. W.; Rheingold, A. L.; Geib, S. J. *J. Chem. Soc., Chem. Commun.* 1988, 1027.
- DiMaio, A.-J.; Rheingold, A. L. *Organometallics* 1987, 6, 1138.
- Rheingold, A. L.; Fountain, M. E. *Organometallics* 1983, 2, 327.
- (a) Rheingold, A. L.; Fountain, M. E. *Organometallics* 1986, 5, 2410. (b) Ang, H. G.; West, B. O. *Aust. J. Chem.* 1967, 20, 1133.
- Elmes, P. S.; Gatehouse, B. M.; West, B. O. *J. Organomet. Chem.* 1974, 82, 235.
- Köpf, H.; Görges, U. *Z. Naturforsch., B: Anorg. Chem., Org. Chem.* 1981, 36B, 1205.
- Mercando, P.; DiMaio, A.-J.; Rheingold, A. L. *Angew. Chem.* 1987, 99, 252; *Angew. Chem., Int. Ed. Engl.* 1987, 26, 244.
- DiMaio, A.-J.; Rheingold, A. L.; Mercado, P., unpublished data.
- Bird, P. H.; McCall, J. M.; Shaver, A.; Siriwardane, U. *Angew. Chem., Int. Ed. Engl.* 1982, 21, 384.
- Köpf, H.; Block, B.; Schmidt, M. *Chem. Ber.* 1968, 101, 272.
- Lee, J. B.; Gajda, G. L.; Schaefer, W. P.; Howard, T. R.; Ikariya, T.; Straus, D. A.; Grubbs, R. H. *J. Am. Chem. Soc.* 1981, 103, 7358.
- Werner, H.; Paul, W.; Zolk, R. *Angew. Chem., Int. Ed. Engl.* 1984, 23, 626. Werner, H.; Paul, W.; Wolf, J.; Steinmetz, M.; Zolk, R.; Müller, G.; Steigelmann, O.; Riede, J. *Angew. Chem., Int. Ed. Engl.* 1989, 122, 1061.
- Jones, R. A.; Whittlesey, B. R. *Organometallics* 1984, 3, 469.
- Jacob, M.; Weiss, E. *J. Organomet. Chem.* 1978, 153, 31.
- Elmes, P. S.; Leverett, P.; West, B. O. *J. Chem. Soc., Chem. Commun.* 1971, 747.
- Fenske, D.; Merzweiler, K. *Angew. Chem., Int. Ed. Engl.* 1984, 23, 635.
- Tebbe, F. N.; Parshall, G. W. *J. Am. Chem. Soc.* 1971, 93, 3793.
- Strong, J.; Rheingold, A. L., unpublished data.
- DiMaio, A.-J. Ph.D. Dissertation, University of Delaware, 1989.
- Guggenburger, L. J.; Meakin, P.; Tebbe, F. N. *J. Am. Chem. Soc.* 1974, 96, 5420.
- Lauher, J. W.; Hoffmann, R. *J. Am. Chem. Soc.* 1976, 98, 1729.
- Elmes, P. S.; West, B. O. *J. Organomet. Chem.* 1971, 32, 365.
- Gatehouse, B. M. *Chem. Commun.* 1969, 948.
- Foust, A. S. Ph.D. Thesis, University of Wisconsin, 1970, p 84.
- (a) Rheingold, A. L.; Churchill, M. R. *J. Organomet. Chem.* 1983, 243, 165. (b) Rheingold, A. L.; Foley, M. J.; Sullivan, P. J. *J. Am. Chem. Soc.* 1982, 104, 4727.
- Rheingold, A. L.; Fountain, M. E. *New J. Chem.* 1988, 12, 565.
- Borowski, R.; Rehder, D.; von Deuten, K. *J. Organomet. Chem.* 1981, 220, 45.
- Rheingold, A. L., unpublished data.
- Huttner, G.; Schmid, H.-G.; Lorenz, H. *Chem. Ber.* 1976, 109, 3741.
- Cotton, F. A.; Webb, T. R. *Inorg. Chim. Acta* 1974, 10, 127.
- Röttinger, E.; Trenkle, A.; Müller, R.; Vahrenkamp, H. *Chem. Ber.* 1980, 113, 1280.
- Calderazzo, F.; Poli, R.; Vitale, D.; Korp, J. D.; Bernal, I.; Pelizzi, G.; Atwood, J. L.; Hunter, W. E. *Gazz. Chim. Ital.* 1983, 113, 761.
- Rheingold, A. L.; Foley, M. J.; Sullivan, P. J. *Organometallics* 1982, 1, 1429.
- Huttner, G.; Sigwarth, B.; Scheidsteger, O.; Zsolnai, L.; Orama, O. *Organometallics* 1985, 4, 326.
- Herrmann, W. A.; Koumboris, B.; Zahn, T.; Ziegler, M. L. *Angew. Chem.* 1984, 96, 802; *Angew. Chem., Int. Ed. Engl.* 1984, 23, 812.
- Cowley, A. H.; Lasch, J. G.; Norman, N. C.; Pakulski, M. *Angew. Chem., Int. Ed. Engl.* 1983, 22, 978.
- Cowley, A. H.; Kilduff, J. E.; Lasch, J. G.; Norman, N. C.; Pakulski, M.; Ando, F.; Wright, T. C. *Organometallics* 1984, 3, 1044.
- (a) Lang, H.; Huttner, G.; Sigwarth, B.; Weber, U.; Zsolnai, L.; Jibril, I.; Orama, O. *Z. Naturforsch., B: Anorg. Chem., Org. Chem.* 1986, 41B, 191. (b) Schugart, K. A.; Fenske, R. F. *J. Am. Chem. Soc.* 1985, 107, 3384.
- Huttner, G.; Jibril, I. *Angew. Chem., Int. Ed. Engl.* 1984, 23, 740.
- Foust, A. S.; Foster, M. S.; Dahl, L. F. *J. Am. Chem. Soc.* 1969, 91, 5631.
- Foust, A. S.; Campana, C. F.; Sinclair, J. D.; Dahl, L. F. *Inorg. Chem.* 1979, 18, 3047.
- Maxwell, L. R.; Hendricks, S. B.; Mosley, V. M. *J. Chem. Phys.* 1935, 3, 699.
- Foust, A. S.; Foster, M. S.; Dahl, L. F. *J. Am. Chem. Soc.* 1969, 91, 5633.
- Greenfield, H.; Sternberg, H. W.; Friedel, R. A.; Wotiz, J. H.; Markby, R.; Wender, I. *J. Am. Chem. Soc.* 1956, 78, 120.
- Sly, W. G. *J. Am. Chem. Soc.* 1959, 81, 18.
- Brown, D. A. *J. Chem. Phys.* 1960, 33, 1037.
- Bernal, I.; Brunner, H.; Meier, W.; Pfisterer, H.; Wachter, J.; Zeigler, M. L. *Angew. Chem., Int. Ed. Engl.* 1984, 23, 438.
- Scherer, O. J.; Sitzmann, H.; Wolmershäuser, G. *J. Organomet. Chem.* 1986, 309, 77.
- Zeigler, M. L.; Blechschmitt, K.; Nuber, B.; Zahn, T. *Chem.*

- Ber.* 1988, 121, 159.
- (72) Sullivan, P. J.; Rheingold, A. L. *Organometallics* 1982, 1, 1547.
- (73) DiMaio, A.-J.; Rheingold, A. L. *J. Chem. Soc., Chem. Commun.* 1987, 404.
- (74) Knox, S. A. R.; Stansfield, R. D. F.; Stone, F. G. A.; Winter, M. J.; Woodward, P. J. *J. Chem. Soc., Dalton Trans.* 1982, 173.
- (75) Müller, M.; Vahrenkamp, H. *J. Organomet. Chem.* 1983, 252, 95.
- (76) Harper, J. R.; Fountain, M. E.; Rheingold, A. L. *Organometallics* 1989, 8, 2316.
- (77) Harper, J. R.; DiMaio, A.-J.; Rheingold, A. L., unpublished data.
- (78) Faller, J. W.; Chodosh, D. F.; Katahira, D. J. *J. Organomet. Chem.* 1980, 187, 227.
- (79) Scherer, O. J.; Brück, T. *Angew. Chem., Int. Ed. Engl.* 1987, 26, 59.
- (80) Scherer, O. J.; Brück, T.; Wolmershäuser, G. *Chem. Ber.* 1988, 121, 935.
- (81) DiVaira, M.; Midollini, S.; Sacconi, L.; Zanobini, F. *Angew. Chem., Int. Ed. Engl.* 1978, 17, 676.
- (82) DiVaira, M.; Midollini, S.; Sacconi, L. *J. Am. Chem. Soc.* 1979, 101, 1757.
- (83) (a) Scherer, O. J.; Sitzmann, H.; Wolmershäuser, G. *Angew. Chem., Int. Ed. Engl.* 1985, 24, 351. (b) Scherer, O. J.; Schwalb, J.; Wolmershäuser, G.; Kaim, W.; Gross, R. *Angew. Chem., Int. Ed. Engl.* 1986, 25, 363. (c) Scherer, O. J.; Schwalb, J.; Swarowsky, H.; Wolmershäuser, G.; Kaim, W.; Gross, R. *Chem. Ber.* 1988, 121, 443.
- (84) (a) Jemmis, E. D.; Reddy, A. C. *Organometallics* 1988, 7, 1561. (b) Tremmel, W.; Hoffmann, R.; Kertesz, M. *J. Am. Chem. Soc.* 1989, 111, 2030.
- (85) Scherer, O. J.; Wiedemann, W.; Wolmershäuser, G. *J. Organomet. Chem.* 1989, 361, C11. Scherer, O. J.; Wiedemann, W.; Wolmershäuser, G. *Chem. Ber.*, in press.
- (86) Scherer, O. J.; Sitzmann, H.; Wolmershäuser, G. *Angew. Chem., Int. Ed. Engl.* 1989, 28, 212.
- (87) DiMaio, A.-J.; Bitterwolf, T.; Rheingold, A. L. *Organometallics*, in press.
- (88) (a) Rheingold, A. L.; Sullivan, P. J. *J. Chem. Soc., Chem. Commun.* 1983, 39. (b) Vizi-Orosz, A.; Galamb, V.; Pályi, G.; Markó, L. *J. Organomet. Chem.* 1976, 107, 235. (c) *Ibid.* 1981, 216, 105. (d) Seyferth, D.; Merola, J. S.; Henderson, R. S. *Organometallics* 1982, 1, 859.
- (89) Fenski, D.; Hachgenei, J. *Angew. Chem.* 1986, 98, 165; *Angew. Chem., Int. Ed. Engl.* 1986, 25, 175.
- (90) Schiferl, D.; Barrett, C. S. *J. Appl. Crystallogr.* 1969, 2, 30.
- (91) Ellermann, J.; Lindner, H. A.; Schnössner, H.; Thiele, G.; Zoubek, G. *Z. Naturforsch., B: Anorg. Chem., Org. Chem.* 1978, 33B, 1386.
- (92) Sigwarth, B.; Zsolnai, L.; Berke, H.; Huttner, G. *J. Organomet. Chem.* 1982, 226, C5.
- (93) DiVaira, M.; Innocenti, P.; Moneti, S.; Peruzzini, M.; Stoppioni, P. *Inorg. Chim. Acta* 1984, 83, 161.
- (94) DiVaira, M.; Peruzzini, M.; Stoppioni, P. *Polyhedron* 1986, 5, 945.
- (95) DiVaira, M.; Moneti, S.; Peruzzini, M.; Stoppioni, P. *J. Organomet. Chem.* 1984, 226, C8.
- (96) DiVaira, M.; Mani, F.; Moneti, S.; Peruzzini, M.; Sacconi, L.; Stoppioni, P. *Inorg. Chem.* 1985, 24, 2230.
- (97) Baldi, G.; DiVaira, M.; Peruzzini, M.; Stoppioni, P. *Gazz. Chim. Ital.* 1986, 116, 329.
- (98) DiMaio, A.-J.; Rheingold, A. L. *Inorg. Chem.*, accepted for publication.
- (99) Dunitz, J. D.; Prelog, V. *Angew. Chem.* 1960, 72, 896.
- (100) Rheingold, A. L.; Fountain, M. E. *New J. Chem.* 1988, 12, 565.
- (101) von Schnering, H.-G.; Wolf, J.; Weber, D.; Ramirez, R.; Meyer, T. *Angew. Chem., Int. Ed. Engl.* 1986, 25, 353.
- (102) Hoffmann, R. *Angew. Chem., Int. Ed. Engl.* 1982, 21, 711.
- (103) (a) Beck, J. A.; Knox, S. A. R.; Stansfield, R. F. D.; Stone, F. G. A.; Winter, M. J. *J. Chem. Soc., Dalton Trans.* 1982, 195. (b) Brammer, L.; Green, M.; Orpen, A. G.; Paddick, K. E.; Saunders, D. R. *J. Chem. Soc., Dalton Trans.* 1986, 657.
- (104) Scherer, O. J.; Vondung, G.; Wolmershäuser, G. *J. Organomet. Chem.*, in press.
- (105) Scherer, O. J.; Braun, J.; Wolmershäuser, G. *Chem. Ber.*, in press.